

Basler Cameras



INSTALLATION AND SETUP GUIDE FOR CAMERAS USED WITH BASLER'S PYLON API

Document Number: AW000611

Version: 03 Language: 000 (English)

Release Date: 8 March 2010

Software Version: 2.2

For customers in the U.S.A.

This equipment has been tested and found to comply with the limits for a Class A digital device, pursuant to Part 15 of the FCC Rules. These limits are designed to provide reasonable protection against harmful interference when the equipment is operated in a commercial environment. This equipment generates, uses, and can radiate radio frequency energy and, if not installed and used in accordance with the instruction manual, may cause harmful interference to radio communications. Operation of this equipment in a residential area is likely to cause harmful interference in which case the user will be required to correct the interference at his own expense.

You are cautioned that any changes or modifications not expressly approved in this manual could void your authority to operate this equipment.

The shielded interface cable recommended in this manual must be used with this equipment in order to comply with the limits for a computing device pursuant to Subpart J of Part 15 of FCC Rules.

For customers in Canada

This apparatus complies with the Class A limits for radio noise emissions set out in Radio Interference Regulations.

Pour utilisateurs au Canada

Cet appareil est conforme aux normes Classe A pour bruits radioélectriques, spécifiées dans le Règlement sur le brouillage radioélectrique.

Life Support Applications

These products are not designed for use in life support appliances, devices, or systems where malfunction of these products can reasonably be expected to result in personal injury. Basler customers using or selling these products for use in such applications do so at their own risk and agree to fully indemnify Basler for any damages resulting from such improper use or sale.

Warranty Note

Do not open the housing of the camera. The warranty becomes void if the housing is opened.

All material in this publication is subject to change without notice and is copyright Basler Vision Technologies.

Contacting Basler Support Worldwide

Europe:

Basler AG
An der Strusbek 60 - 62
22926 Ahrensburg
Germany

Tel.: +49-4102-463-515
Fax.: +49-4102-463-599

bc.support.europe@baslerweb.com

Americas:

Basler, Inc.
855 Springdale Drive, Suite 203
Exton, PA 19341
U.S.A.

Tel.: +1-610-280-0171
Fax.: +1-610-280-7608

bc.support.usa@baslerweb.com

Asia:

Basler Asia Pte. Ltd
8 Boon Lay Way
03 - 03 Tradehub 21
Singapore 609964

Tel.: +65-6425-0472
Fax.: +65-6425-0473

bc.support.asia@baslerweb.com

www.baslerweb.com

Table of Contents

1	Introduction	1
1.1	Software Licensing Information	2
1.1.1	LWIP TCP/IP	2
1.1.2	pylon API	3
2	Precautions	5
2.1	Avoiding EMI and ESD Problems	9
3	What You Must Know Before You Begin Installing	11
3.1	System Requirements	12
3.2	Installation Packages	12
3.3	pylon Software Features and General Recommendations for Selection	13
3.3.1	Recommended Combinations of Software Features	15
3.4	Installation Procedures Depend On Starting Conditions	17
4	Removal of Old pylon Software	19
5	Installing a GigE Vision Camera	21
5.1	General Considerations	21
5.1.1	Installation Procedure	22
5.1.2	What Happens When Installing a Basler GigE Vision Network Driver	22
5.2	Basler pylon Software Installation	24
5.3	Adjusting the Installation	27
5.3.1	Configuring a Network Adapter Used with the Filter Driver	27
5.3.2	Disabling the Windows Firewall	31
5.4	Hardware Installation	35
5.5	Network Recommendations	40
5.5.1	If You Are Using Multiple Network Adapters in a Single PC	40
5.5.2	Recommended Network Adapters	41
5.5.3	Recommended Network Architectures	42
5.6	Camera and Network Adapter IP Configuration	46
5.6.1	Network Adapter IP Behavior	47
5.6.2	Changing a Network Adapter's IP Configuration	48
5.6.2.1	Setting an Adapter to Use a Fixed IP Address	48
5.6.2.2	Setting an Adapter to Use DHCP/Alternate Configuration = APIPA	51
5.6.2.3	Checking a Network Adapter's IP Address	54
5.6.3	Camera IP Behavior	55
5.6.4	Changing a Camera's IP Configuration	57
5.7	Modifying the Installation	61
5.7.1	Changing the Driver Association for a Compatible GigE Network Adapter	61
5.7.2	Unbinding the Basler Filter Driver from a Network Adapter	62
5.7.3	Modifying Your Software Installation	63

6	Installing an IEEE 1394 Camera	65
6.1	General Considerations	65
6.1.1	Installation Procedure	67
6.2	Software and Hardware Installation	68
6.2.1	Installing the Basler pylon Software	68
6.2.2	Associating an IEEE 1394 Driver with Your Camera	71
6.2.3	Modifying Your Software Installation	73
7	Installing a Camera Link Camera	75
7.1	General Considerations	75
7.2	Frame Grabber Preparations	77
7.2.1	Location of the Serial Port File	77
7.2.2	Frame Grabber "Camera Files"	78
7.3	Hardware Installation	78
7.4	Basler pylon Software Installation	80
7.5	Configuring the Camera Link Serial Port	83
7.6	Modifying Your Software Installation	84
8	Acquiring Images	85
8.1	Acquiring Your First Images	85
8.2	Adjusting Image Quality	92
9	Next Steps	97
	Feedback	99
	Index	101
	Revision History	103

1 Introduction

This document provides the information you will need to install and operate Basler GigE Vision, IEEE 1394, and Camera Link[®] cameras. The installation procedure relates to both hardware and Basler pylon software.

Unless otherwise noted, the material in this manual applies to all Basler cameras using Basler pylon software, regardless of camera model or type of interface.

We strongly recommend that you read and follow the precautions given in this document and all further precautions given in the camera user manuals.

Refer to the camera user manuals for additional important information such as:

- mechanical specifications, including mounting points
- mechanical stress test results
- environmental requirements.

If you are using a GigE Vision camera, refer to the camera's User Manual for information on improving your camera's performance in a network and on using multiple cameras.

1.1 Software Licensing Information

1.1.1 LWIP TCP/IP

The software in the camera includes the LWIP TCP/IP implementation. The copyright information for this implementation is as follows:

Copyright (c) 2001, 2002 Swedish Institute of Computer Science. All rights reserved.

Redistribution and use in source and binary forms, with or without modification, are permitted provided that the following conditions are met:

1. Redistributions of source code must retain the above copyright notice, this list of conditions and the following disclaimer.
2. Redistributions in binary form must reproduce the above copyright notice, this list of conditions and the following disclaimer in the documentation and/or other materials provided with the distribution.
3. The name of the author may not be used to endorse or promote products derived from this software without specific prior written permission.

THIS SOFTWARE IS PROVIDED BY THE AUTHOR ``AS IS" AND ANY EXPRESS OR IMPLIED WARRANTIES, INCLUDING, BUT NOT LIMITED TO, THE IMPLIED WARRANTIES OF MERCHANTABILITY AND FITNESS FOR A PARTICULAR PURPOSE ARE DISCLAIMED.

IN NO EVENT SHALL THE AUTHOR BE LIABLE FOR ANY DIRECT, INDIRECT, INCIDENTAL, SPECIAL, EXEMPLARY, OR CONSEQUENTIAL DAMAGES (INCLUDING, BUT NOT LIMITED TO, PROCUREMENT OF SUBSTITUTE GOODS OR SERVICES; LOSS OF USE, DATA, OR PROFITS; OR BUSINESS INTERRUPTION) HOWEVER CAUSED AND ON ANY THEORY OF LIABILITY, WHETHER IN CONTRACT, STRICT LIABILITY, OR TORT (INCLUDING NEGLIGENCE OR OTHERWISE) ARISING IN ANY WAY OUT OF THE USE OF THIS SOFTWARE, EVEN IF ADVISED OF THE POSSIBILITY OF SUCH DAMAGE.

1.1.2 pylon API

The pylon API is based on the GenApi module of the GenICam™ reference implementation distributed under a modified BSD license and is copyright (c) 2005, Basler Vision Technologies. All rights reserved. Redistribution and use in source and binary forms, without modification, are permitted provided that the following conditions are met:

- Redistributions of the source code must retain the above copyright notice, this list of conditions, and the following disclaimer.
- Redistributions in binary form must reproduce the above copyright notice, this list of conditions, and the following disclaimer in the documentation and/or other materials provided with the distribution.
- Neither the name of the GenICam standard group nor the names of its contributors may be used to endorse or promote products derived from this software without specific prior written permission.

THIS SOFTWARE IS PROVIDED BY THE COPYRIGHT HOLDERS AND CONTRIBUTORS "AS IS" AND ANY EXPRESS OR IMPLIED WARRANTIES, INCLUDING, BUT NOT LIMITED TO, IMPLIED WARRANTIES OF MERCHANTABILITY AND FITNESS FOR A PARTICULAR PURPOSE ARE DISCLAIMED. IN NO EVENT SHALL THE COPYRIGHT OWNER OR CONTRIBUTORS BE HELD LIABLE FOR ANY DIRECT, INDIRECT, INCIDENTAL, SPECIAL, EXEMPLARY, OR CONSEQUENTIAL DAMAGES (INCLUDING, BUT NOT LIMITED TO, PROCUREMENT OF SUBSTITUTE GOODS OR SERVICES; LOSS OF USE, DATA, OR PROFITS; OR BUSINESS INTERRUPTION) HOWEVER CAUSED AND BASED ON ANY THEORY OF LIABILITY, WHETHER IN CONTRACT, STRICT LIABILITY, OR TORT (INCLUDING NEGLIGENCE OR OTHERWISE) ARISING IN ANY WAY OUT OF THE USE OF THIS SOFTWARE, EVEN IF ADVISED OF THE POSSIBILITY OF SUCH DAMAGE.

2 Precautions

NOTICE

Avoid dust on the sensor.

1. The camera is shipped with a cap or plastic seal on the lens mount. To avoid collecting dust on the camera's IR cut filter (color cameras) or sensor (mono cameras), make sure that you always put the cap or plastic seal in place when there is no lens mounted on the camera.

NOTICE

Lens thread length is limited.

1. Color models of the scout, pilot, aviator, and ace cameras with a C-mount lens adapter are equipped with an IR cut filter mounted inside of the adapter. The location of this filter limits the length of the threads on any lens you use with the camera. If a lens with a very long thread length is used, the IR cut filter will be damaged or destroyed and the camera will no longer operate.

For more specific information about the lens thread length, see the camera user manuals.

NOTICE

Voltage outside of specified range can damage the GigE Vision scout and pilot camera.

1. If the voltage of the power applied to the camera is greater than +24 VDC damage to the camera can result. If the voltage is less than +12 VDC, the camera may operate erratically.

NOTICE

Applying incorrect power can damage the runner and aviator camera.

1. The camera's nominal operating voltage is +12 VDC ($\pm 10\%$). If the voltage applied to the camera is greater than +13.2 VDC, severe damage to the camera can result. If the voltage is less than +10.8 VDC, the camera may operate erratically.
2. Make sure that the polarity of the power applied to the camera is correct. Applying power with the wrong polarity can result in severe damage to the camera.

NOTICE

Voltage outside of the specified range can damage the ace camera.

1. If you are supplying camera power via Power over Ethernet (PoE), the power must comply with the IEEE 1394 802.3af specification.
2. If you are supplying camera power via the camera's 6-pin connector and the voltage of the power is greater than +30.0 VDC, damage to the camera can result. If the voltage is less than +11.3 VDC, the camera may operate erratically.

NOTICE

Incorrect power can damage the IEEE 1394 scout camera.

1. The polarity of the power on the camera's IEEE 1394b socket must be as shown in the pin assignment table of your camera User's Manual. **Do not** reverse the power polarity. Reversing the polarity will damage the camera.
2. If the voltage applied to the camera is greater than +36 VDC, damage to the camera can result. If the voltage is less than +8 VDC, the camera may operate erratically.

NOTICE

An incorrect plug can damage the scout and pilot camera's 12-pin connector.

1. The plug on the cable that you attach to the camera's 12-pin connector must have 12 pins. Use of a smaller plug, such as one with 10 pins or 8 pins, can damage the pins in the camera's 12-pin connector.

NOTICE

Incorrect plugs can damage the runner and aviator camera's connectors.

1. The plug on the cable that you attach to the camera's 12-pin connector must have 12 female pins. Using a plug designed for a smaller or a larger number of pins can damage the connector.
2. The plug on the cable that you attach to the camera's 6-pin connector must have 6 female pins. Using a plug designed for a smaller or a larger number of pins can damage the connector.

NOTICE

An incorrect plug can damage the ace camera's 6-pin connector.

1. The plug on the cable that you attach to the camera's 6-pin connector must have 6 female pins. Using a plug designed for a smaller or a larger number of pins can damage the connector.

NOTICE

Making or breaking connections incorrectly can damage the aviator camera.

1. Be sure that all power to your camera and to your host PC is switched off before you make or break connections to the camera. Making or breaking connections when power is on can result in damage to the camera or to the frame grabber.
2. If you can't switch off the power, be sure that:
 - a. The input power plug is the last connector that you plug into the camera when making connections.
 - b. The input power plug is the first connector that you unplug from the camera when breaking connections.

Warranty Precautions

To ensure that your warranty remains in force:

Do not remove the camera's serial number label

If the label is removed and the serial number can't be read from the camera's registers, the warranty is void.

Do not open the camera housing

Do not open the housing. Touching internal components may damage them.

Keep foreign matter outside of the camera

Be careful not to allow liquid, flammable, or metallic material inside of the camera housing. If operated with any foreign matter inside, the camera may fail or cause a fire.

Avoid Electromagnetic fields

Do not operate the camera in the vicinity of strong electromagnetic fields. Avoid electrostatic charging.

Transport Properly

Transport the camera in its original packaging only. Do not discard the packaging.

Clean Properly

Avoid cleaning the surface of the camera's sensor if possible. If you must clean it, use a soft, lint free cloth dampened with a small quantity of high quality window cleaner. Because electrostatic discharge can damage the sensor, you must use a cloth that will not generate static during cleaning (cotton is a good choice).

To clean the surface of the camera housing, use a soft, dry cloth. To remove severe stains, use a soft cloth dampened with a small quantity of neutral detergent, then wipe dry.

Do not use solvents or thinners to clean the housing; they can damage the surface finish.

Read the manual

Read the manual carefully before using the camera!

2.1 Avoiding EMI and ESD Problems

The cameras are frequently installed in industrial environments. These environments often include devices that generate electromagnetic interference (EMI) and they are prone to electrostatic discharge (ESD). Excessive EMI and ESD can cause problems with your camera such as false triggering or can cause the camera to suddenly stop capturing images. EMI and ESD can also have a negative impact on the quality of the image data transmitted by the camera.

To avoid problems with EMI and ESD, you should follow these general guidelines:

- Always use high quality shielded cables. The use of high quality cables is one of the best defenses against EMI and ESD.
- Try to use camera cables that are the correct length and try to run the camera cables and power cables parallel to each other. Avoid coiling camera cables. If the cables are too long, use a meandering path rather than coiling the cables.
- Avoid placing camera cables parallel to wires carrying high-current, switching voltages such as wires supplying stepper motors or electrical devices that employ switching technology. **Placing camera cables near to these types of devices may cause problems with the camera.**
- Attempt to connect all grounds to a single point, e.g., use a single power outlet for the entire system and connect all grounds to the single outlet. This will help to avoid large ground loops. (Large ground loops can be a primary cause of EMI problems.)
- Use a line filter on the main power supply.
- Install the camera and camera cables as far as possible from devices generating sparks. If necessary, use additional shielding.
- Decrease the risk of electrostatic discharge by taking the following measures:
 - Use conductive materials at the point of installation (e.g., floor, workplace).
 - Use suitable clothing (cotton) and shoes.
 - Control the humidity in your environment. Low humidity can cause ESD problems.



The Basler application note called *Avoiding EMI and ESD in Basler Camera Installations* provides much more detail about avoiding EMI and ESD.

The application note can be downloaded at:

www.baslerweb.com/indizes/download_index_en_31412.html

3 What You Must Know Before You Begin Installing

This document provides the information you will need to install and operate a GigE Vision, an IEEE 1394, and a Camera Link[®] camera. The installation procedures include both software and hardware installation.

The installation procedures assume that you want to get your camera operational and begin capturing images as quickly and as simply as possible. Accordingly, the procedures describe a desktop installation for one camera and assumes that you will be using the "pylon Viewer" software from Basler to capture your first images.

**Note**

The Installation of Basler pylon 2.2 software will involve removing all previous Basler pylon software.

If you want to preserve old Basler pylon software, do not install Basler pylon 2.2 software.

The installation procedure assumes that you are installing version 2.2 of the pylon software. If you have an older version of the software, obtain version 2.2 before you begin the installation. If you have a newer version of the software, see the installation guide of the newer version.

The software installation procedure assumes that there is no camera connected to the computer. If there is a camera connected, you should disconnect it now. You will connect your camera to the computer later in the installation routine.

3.1 System Requirements

The Basler pylon software requires that one of the following operating systems is installed on your computer:

32 bit operating systems:

- Windows 2000 SP4
- Windows XP SP2/SP3
- Windows Vista

64 bit operating systems:

- Windows XP x64 SP2
- Windows Vista x64

3.2 Installation Packages

For the Basler pylon Driver Package there are different installers available, depending on the operating system:

For 32 bit operating systems:

- **Basler pylon SDKx86 x.x.x.xxx.exe**

For 64 bit operating systems:

- **Basler pylon SDK x64 x.x.x.xxx.exe**



Note

You must install the 32 bit version of the Basler pylon software if you use a 32 bit Windows operating system and you must install the 64 bit version of the Basler pylon software if you use a 64 bit Windows operating system. Otherwise, the Basler pylon software will not run.

If you install the 64 bit version all corresponding features of the 32 bit version will also be installed.

3.3 pylon Software Features and General Recommendations for Selection

The Basler pylon Driver Package includes these software features:

- The **Basler pylon Runtime Environment**:
 - pylon GigE Vision[®] network drivers:
 - The **Basler pylon GigE Vision filter driver** - a basic GigE Vision network driver that will work with all network adapters (i.e., both "non-compatible" and "compatible" network adapters). The advantage of the filter driver is its extensive compatibility.
 - The **Basler pylon GigE Vision performance driver** - a hardware specific GigE Vision network driver. The performance driver will only work with "compatible" network adapters, i.e., adapters that use specific Intel chipsets. The advantage of the performance driver is that it significantly lowers the CPU load needed to service the network traffic between the PC and the camera(s). It also has a more robust packet resend mechanism. **We strongly recommend using the Basler pylon GigE Vision performance driver for "compatible" network adapters instead of the Basler pylon GigE Vision filter driver.** For more information about "non-compatible" and "compatible" network adapters and Intel chipsets, see the "Recommended Network Adapters" section.
 - The **Basler pylon IP Configuration Tool** - a tool for the camera's IP and user ID configuration.
 - pylon IEEE 1394 drivers:
 - The **Basler pylon IEEE 1394 Bus Driver** - a driver for the IEEE 1394 bus.
 - The **Basler pylon IEEE 1394 Camera Driver** - a camera driver for IEEE 1394 cameras.
 - The **Basler pylon Camera Link[®] Driver** - a camera driver for Camera Link cameras; only available for 32 bit operating systems.

Note: Only Basler aviator Camera Link cameras are supported.

 - The **Basler pylon Camera Link Configuration Tool** - a tool for selecting the ports for communication between the camera and the PC (frame grabber).
 - Additional runtimes:
 - The **Basler pylon C Runtime** - a runtime for applications written in C.
 - The **Basler pylon VB6 Runtime** - a runtime for applications written in Visual Basic 6.
 - The **Basler pylon .NET Runtime** - a runtime for applications written in a .NET language. This feature requires the .NET Framework 2.0 Redistributable Package suitable for the operating system to be installed. If you have not already done so, install the suitable .NET Framework Redistributable Package. You can download the .NET Framework 2.0 Redistributable Package for a 32 bit operating system from: <http://www.microsoft.com/downloads/details.aspx?displaylang=en&FamilyID=0856each-4362-4b0d-8edd-aab15c5e04f5>
 - The **Extend PATH Environment Variable** feature - to avoid potential conflict with other GenICam 2.0 software. This feature should only be deselected if other GenICam 2.0 software is installed as well.

- The **Basler pylon Viewer** - an application that can be used to easily parameterize the camera and acquire images.
- The **Speed-O-Meter** - a tool for monitoring the camera's frame rate and its bandwidth usage.
- The **Basler pylon DirectShow driver** - a driver for use with applications that display images using the Windows DirectShow API.
- The **Basler pylon TWAIN Driver** - a TWAIN driver for Basler cameras.
- The **Basler pylon SDK & Samples**
 - **pylon SDK for C++** - an SDK for developing in C++, using VS 2003 or higher
 - **pylon SDK for C** - an SDK for developing in C.
 - **pylon SDK for VB6** - an SDK for developing in Visual Basic 6.
 - **pylon SDK for .NET** - an SDK for developing in in a .NET lanuage. This feature requires the .NET Framework 2.0 Redistributable Package suitable for the operating system to be installed. If you have not already done so, install the suitable .NET Framework Redistributable Package. You can download the .NET Framework 2.0 Redistributable Package for a 32 bit operating system from: <http://www.microsoft.com/downloads/details.aspx?displaylang=en&FamilyID=0856eacb-4362-4b0d-8edd-aab15c5e04f5>

The SDKs include API header files and libraries that you will need to create your own application programs, a set of sample programs that illustrates how to use the camera API to parameterize the camera and acquire images, and a programmer's guide and API reference.

- The **Basler pylon Debug Runtime Environment** - debug versions of the pylon libraries, used for debugging in the C++ or C SDK only.



We recommend to install only the needed software features and to exclude those from installation that are not needed by deselecting them. The deselected software features will nonetheless be saved on your PC. If you want to install them later, you can easily install them from your PC.

3.3.1 Recommended Combinations of Software Features

The following table indicates which software features you should select for installation, depending on the type of camera interface, programming language used for developing, and API.

Software Feature	GigE	IEEE 1394	Camera Link	C++	C	VB6	.NET	DirectShow	TWAIN
pylon Runtime Environment	A	A	A	A	A	A	A	A	A
pylon GigE Vision Drivers	X								
GEV Filter Driver	X								
GEV Performance Driver	X								
pylon IP Configuration Tool	X								
pylon IEEE 1394 Drivers		X							
pylon IEEE 1394 Bus Driver		X							
pylon IEEE 1394 Camera Driver		X							
pylon Camera Link Driver			X						
pylon CL Configuration Tool			X						
pylon Additional Runtimes									
pylon C Runtime	O ¹	O ¹	O ¹						
pylon VB6 Runtime	O ¹	O ¹	O ¹						
pylon .NET Runtime	O ¹	O ¹	O ¹						
Extend PATH Environment Variable	X ²	X ²	X ²	X ²	X ²	X ²	X ²	X ²	X ²
pylon Viewer	X	X	X						
Speed-O-Meter	O	O							
pylon DirectShow Driver								X	
pylon TWAIN Driver									X
SDKs									
pylon SDK for C++				X					
pylon SDK for C					X				
pylon SDK for VB6						X			
pylon SDK for .NET							X		
pylon Debug Runtime Environment				X	X				

A: always installed

X: select the feature for installation

O: optionally select the feature for installation

¹ Only needed for a "runtime only" installation for C, VB6 or .NET applications. If you install the SDK for C, VB6 or .NET, the corresponding runtime will automatically be installed.

² Deselect only when also using other GenICam 2.0 software.

3.4 Installation Procedures Depend On Starting Conditions

If you have version 2.1 or below of the pylon software on your computer, go through the installation procedure in this manner:

- First, go to the "Removal of Old pylon Software" section and uninstall **all** old pylon software.
- Next,
 - if you want to install a Basler GigE camera go to the "Installing a GigE Vision Camera" section.
 - if you want to install a Basler IEEE 1394 camera go to the "Installing an IEEE 1394 Camera" section.
 - if you want to install a Basler Camera Link camera go to the "Installing a Camera Link Camera" section.
- Next, go to the "Acquiring Images" section.
- Next, go to the "Next Steps" section.
- If you have installed a Basler GigE camera refer to the camera User's Manual for information on improving your camera's performance in a network and on using multiple cameras.

If there is no pylon software on your computer, go through the installation procedure in this manner:

- First,
 - if you want to install a Basler GigE camera go to the "Installing a GigE Vision Camera" section.
 - if you want to install a Basler IEEE 1394 camera go to the "Installing an IEEE 1394 Camera" section.
 - if you want to install a Basler Camera Link camera go to the "Installing a Camera Link Camera" section.
- Next, go to the "Acquiring Images" section.
- Next, go to the "Next Steps" section.
- If you have installed a Basler GigE camera refer to the camera User's Manual for information on improving your camera's performance in a network and on using multiple cameras.

4 Removal of Old pylon Software

If you have older Basler pylon software on your system, you must uninstall it completely before installing Basler pylon 2.2 software.



Note

If you want to preserve an older version of Basler pylon software on your system, do not install pylon 2.2 software. You will otherwise delete the installation of older Basler pylon software on your system.

To uninstall an older version of Basler pylon software:

1. Uninstall the older version of Basler pylon software completely by using the Windows uninstallation routine:
 - a. Click **Start** and click **Control Panel**. The **Control Panel** window opens.
 - b. Click **Add or Remove Programs**. The **Add or Remove Programs** window opens.
 - c. In the list of the currently installed programs, select all pylon software features and click the **Remove** button.
 - d. Close the **Add or Remove Programs** window and the **Control Panel** window.
2. **Reboot your computer.**

The older Basler pylon software is uninstalled.

To install the latest version of Basler pylon software with a GigE Vision camera, go to [Section 5.2](#).
To install the latest version of Basler pylon software with an IEEE 1394 camera, go to [Section 6.2](#).
To install the latest version of Basler pylon software with a Camera Link camera, go to [Section 7.4](#).

5 Installing a GigE Vision Camera

5.1 General Considerations

The installation procedures assume that you will be making a peer-to-peer connection between your camera and a desktop computer. Make sure that the following items are available before starting the installation:

- A Basler GigE camera.
- As applicable a power supply or a GigE power injector:
Make sure that the power supply meets all of the requirements listed in the Physical Interface section of the camera User's Manual.
If you want to use Power over Ethernet (PoE) as an alternative for the ace camera use a GigE power injector.
- As applicable, a C-mount or an F-mount lens for the camera.
If you already know what lens you will be using in your actual application, use this lens during the camera installation and setup. If not, we suggest that you use a zoom lens for your initial installation and setup. Contact Basler technical support if you need assistance in determining the best lens for your application. The support contact numbers appear in the title pages of this manual.
- A desktop computer with a GigE network adapter installed. We recommend that you use an Intel® PRO 1000 series adapter. These adapters have been tested with Basler cameras and work well. This installation procedure assumes that your computer is equipped with a PRO 1000 series adapter.
The desktop computer must be equipped with an appropriate operating system (see the "System Requirements" section).
- A standard Ethernet patch cable. We recommend the use of a category 6 or category 7 cable that has S/STP shielding (two cables if you are using a power injector).
- Basler pylon Software:
You can download the Basler pylon Driver Package at: www.baslerweb.com.

You should perform the software installation procedure first and the hardware installation procedure second.

5.1.1 Installation Procedure

Go through the software installation procedure in this manner:

- First, read the "What Happens When Installing A Basler GigE Vision Network Driver" section.
- Next, go to the "Basler pylon Software Installation" section and install the software.
- Next, go to the "Adjusting the Installation" section, to configure any Fast Ethernet or non-compatible network adapter used for the camera and to adjust the installation if necessary. The adjustments may, for example, involve reestablishing an original network driver - network adapter association, unbinding a Basler network driver from a network adapter, or installing an individual software feature that is not included in your current Basler pylon installation.
- If you will be connecting cameras to more than one network adapter in a single PC, read the "Using Multiple Adapters in One PC" section.

5.1.2 What Happens When Installing a Basler GigE Vision Network Driver

During installation of the Basler pylon Driver Package, Basler network drivers are bound to all network adapters installed in your computer. This applies not only to all network adapters used to connect to cameras, but also to all other network adapters installed in your PC. Often, your PC will have two network adapters installed, with one used to connect to cameras and the other used to connect to a local area network.

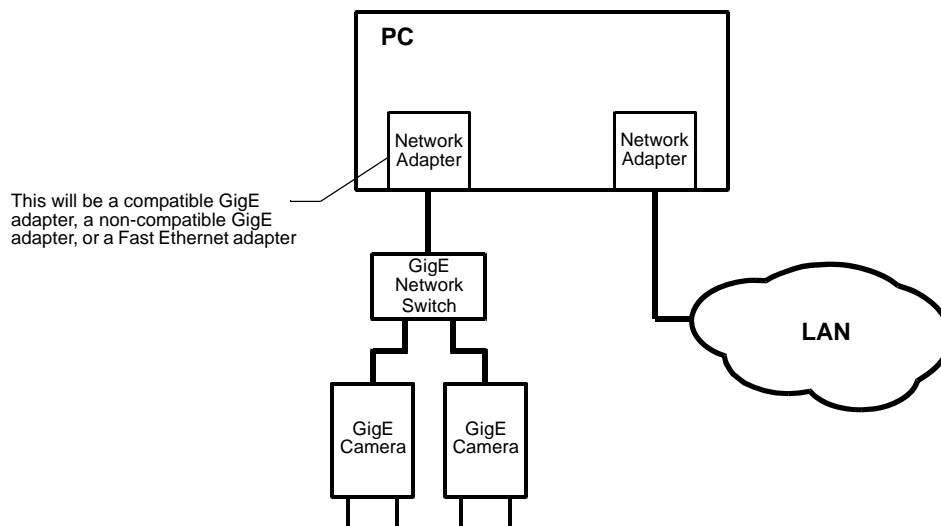

Fig. 1: Network Adapter for the Camera(s)

Two drivers are available for use with your GigE cameras:

- The **Basler filter driver** - is a basic GigE Vision network driver that is compatible with all network adapters. The advantage of the filter driver is its extensive compatibility.
- The **Basler performance driver** - is a hardware specific GigE Vision network driver. The performance driver is only compatible with network adapters that use specific Intel chipsets ("compatible chipsets"). The advantage of the performance driver is that it significantly lowers the CPU load needed to service the network traffic between the PC and the camera(s). It also has a more robust packet resend mechanism.



Note

If you are using a compatible GigE network adapter, the installation of the Basler pylon Driver Package will remove the driver that is currently installed for the adapter and will install the Basler performance driver. In addition, the Basler filter driver will be bound to the network adapter as a service which, however, will not be enabled.

If you are using a non-compatible GigE or a Fast Ethernet network adapter, the installation of the Basler pylon Driver Package will bind the Basler filter driver to the network adapter as a service and will enable the service.

For information about reestablishing a previous association with the original driver for a compatible network adapter, see the "Changing the Driver Association for a Compatible GigE Network Adapter" section on [page 61](#).

For information about unbinding the filter driver see the "Unbinding the Basler Filter Driver from a Network Adapter" section on [page 62](#).

For more information about compatible chipsets, see Section 5.5.2 on [page 41](#).

5.2 Basler pylon Software Installation



Note

During installation of the Basler pylon GigE Vision performance driver, **all** current associations in your PC between network drivers and compatible GigE network adapters will be changed, with the performance driver replacing the current drivers.

If you want to reestablish the original network adapter-driver association for a compatible GigE network adapter, see the "Changing the Driver Association for a Compatible GigE Network Adapter" section.



Note

After installation of the Basler filter driver, we recommend unbinding the Basler filter driver from a network adapter that is not used with a camera, and from a network adapter that is used with the performance driver. For details, see the "Unbinding the Basler Filter Driver from a Network Adapter" section.

For the installation, choose the appropriate name of the installer from [Table 1](#), depending on the operating system of your PC.

You can obtain the Basler pylon Driver Package as a download from the Basler website: www.baslerweb.com.

	32 bit Operating System	64 bit Operating System
Basler pylon Driver Package	Basler pylon SDK x86 x.x.x.xxx.exe	Basler pylon SDK x64 x.x.x.xxx.exe

Table 1: Installer Names

1. Make sure your GigE camera is disconnected from your computer.
2. Close all open applications.
3. Download the installer from the Basler website (www.baslerweb.com) to a local directory of your computer (for possible installer names, see [Table 1](#)).
4. Launch the downloaded executable.
The program will prepare to install and then a **Welcome** window will open.
5. Click the **Next** button.
A **License Agreement** window will open.
6. Accept the agreement and click the **Next** button.

A **Customer Information** window will open.

7. Enter the appropriate information and click the **Next** button.
8. In the **Destination** window determine the directory where you want to install the software to and click the **Next** button.

A **Custom Setup** window will open.

- a. Deselect the features of the pylon software that you do not want to install.
- b. Only select those features of the pylon software you want to install.

The example shown below assumes that you will only use GigE cameras, and that your applications and software development only use C++.

See the "pylon Software Features and General Recommendations for Selection" section for information about the software features and recommendations about combining software features for installation.

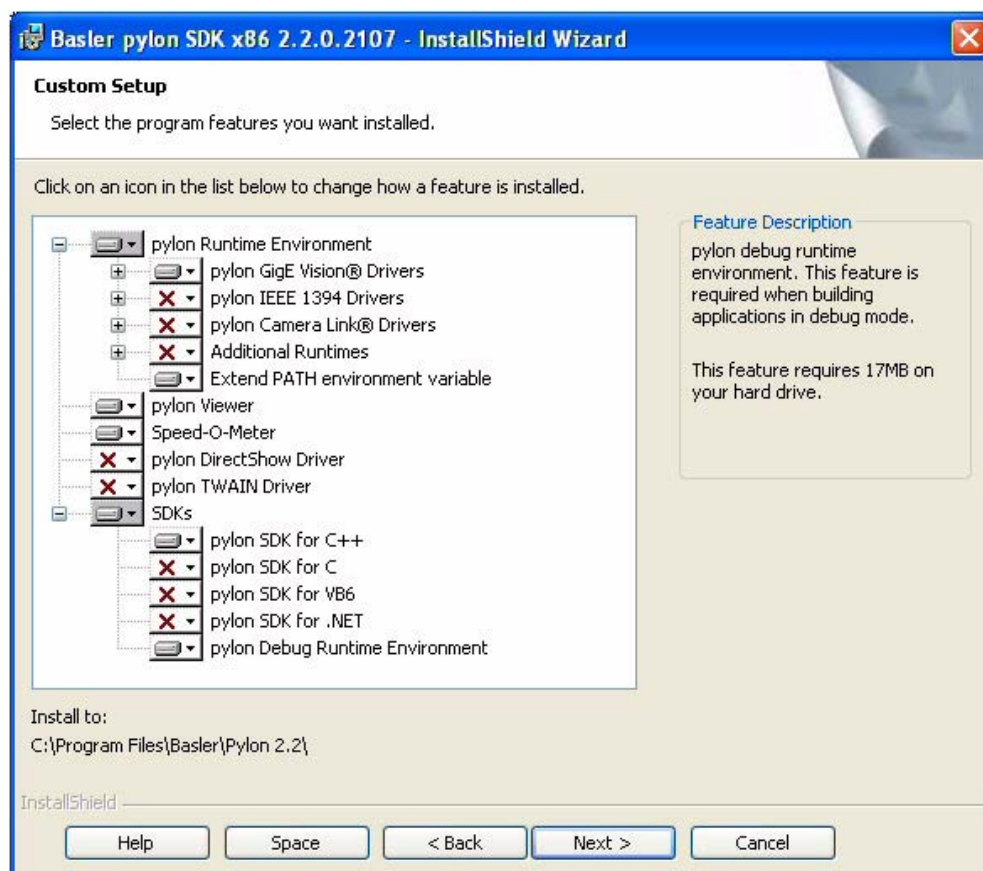

Note

The deselected software features will not be installed. They will, however, be saved on your PC. Therefore, if you want to install them later, you can easily install them from your PC.

For more information, see the "Installing a Software Feature" section.

9. Click the **Next** button.
10. A **Ready to Install the Program** window will open.

**Note**

Before proceeding, close all applications needing a network connection. Otherwise, the network connections for your applications will temporarily be lost.

11. Click the **Install** button.
When the installation process is complete, a **Completed** window will open.
12. Click the **Finish** button.
13. An **Installer Information** window may open informing about the need to restart the computer.
 - If you want to restart the computer now, click the **Yes** button.
 - If you want to restart the computer later, click the **No** button.

If the **Installer Information** window does not open, there is no need to restart the computer.

Note that the installation program has added shortcuts to the desktop for the **Pylon Viewer** and the **Pylon IP Configuration Tool**.

14. To see the installed software features:
Click **Start > All Programs > Basler Vision Technologies > Pylon 2.2**.

The Basler pylon software installation is complete.

**Note**

If you installed the Basler filter driver (i.e. if you did not deselect the Basler filter driver):

- Make sure to configure the network adapter to be used with the Basler filter driver as described in the "Configuring a Network Adapter Used with the Filter Driver" section.
- If you are using several adapters, you must configure each network adapter to be used with Basler filter driver individually.
- We recommend unbinding a Basler network driver from a network adapter that is not used with a camera, or from a network adapter that is used with the Performance driver. For details, see the "Unbinding the Basler Filter Driver from a Network Adapter" section.

5.3 Adjusting the Installation

This section provides information on adjustments that must be made after the installation of the Basler pylon Driver Package and on additional adjustments that may be needed.

Necessary adjustments:

- Disabling the Windows firewall
- Configuring the Fast Ethernet or non-compatible GigE network adapters that you may use with your cameras
- Realizing a better performance by
 - Setting the **Jumbo Frames** parameters
 - Setting the **Interrupt Moderation Rate**
 - Setting the speed and duplex mode parameter
- Adjusting network performance

Possibly necessary additional adjustments:

- Changing the driver association for a compatible GigE network adapter (see [page 61](#))
- Unbinding the Basler filter driver from a network adapter (see [page 62](#))
- Installing an individual Basler pylon software feature that is not currently installed (see [page 63](#)).

5.3.1 Configuring a Network Adapter Used with the Filter Driver

The following procedures assume that the Basler filter driver was installed on your PC during Installation of the Basler pylon Driver Package, or as an individual software feature. After the installation, the settings of each network adapter used with the filter driver must be checked and adjusted, if necessary.

The configuration will usually address non-compatible and Fast Ethernet network adapters which can only be used with the filter driver. Compatible network adapters must also be configured if used with the filter driver. We, however, strongly recommend using the performance driver for compatible network adapters. These need not be configured if used with the performance driver.

Modifying the Network Connections

1. Open the **Network Connections** window and find the connection for your network adapter that is used with cameras. (Make sure that the window is set to display details (right click within the window, select **View**, and select **Details**).

If you have multiple Fast Ethernet or non-compatible GigE adapters that are used with your cameras, select any one of them.

2. Right click on the name of the connection and select **Properties** from the drop down menu as shown below.

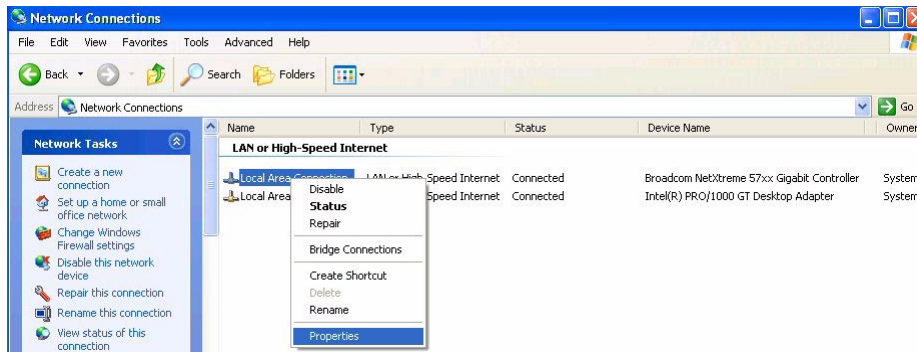

3. A ... **Properties** window will open as shown below.

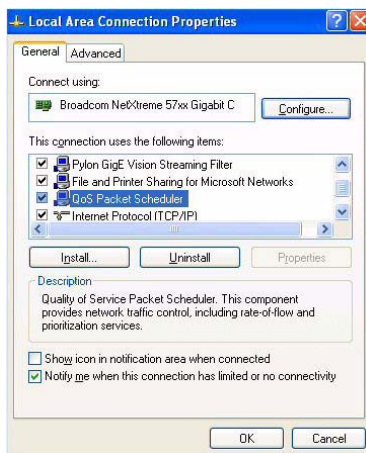

4. Look at the list of items in the center of the ... **Properties** window.
 - a. Make sure that the **Pylon GigE Vision Streaming Filter** and the **Internet Protocol (TCP/IP)** items are checked as shown below.
 - b. Make sure that all of the other items in the list are unchecked. (Note that you may need to scroll the list up or down to see all of the items.)

- c. Click the **Close** or the **OK** button on the ... **Properties** window (either a **Close** or an **OK** button will be present depending on what changes you made). In this way you make sure that the changes become valid.

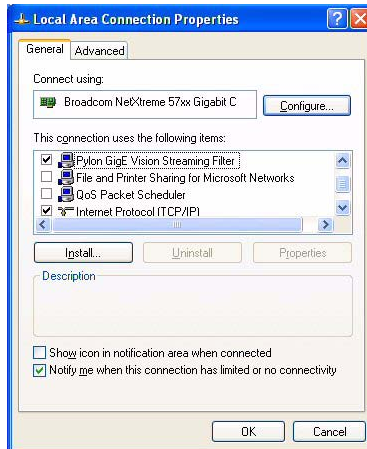

Modifying the Network Adapter

1. In the **Network Connections** window, right click on the name of the connection for your network adapter, and select **Properties** from the drop down menu.
2. Click the **Configure...** button.
A controller properties window will open.
3. Click on the **Advanced** tab. Select the following parameters in the **Properties** group and set their values in the **Value** group:

Note: Depending on the network adapter model, the parameter names of your network adapter may differ from the ones shown below. Also, the ways of setting the parameters may differ, and some parameters may not be available.

Contact Basler technical support if you need assistance.

- a. Select the **Jumbo Frames** (or **Jumbo Packets**) parameter and set its size to the maximum value.
 - b. If no **Jumbo Frames** parameter is present, select the parameter which relates to frame size and set its size to the maximum value, which typically is 1.5 kB
 - c. Select the parameter which relates to the number of receive descriptors (e.g. **Receive Descriptors**) and set it to its maximum value.
 - d. Select the parameter which relates to the number of CPU interrupts (e.g. **Interrupt Moderation Rate**) and set it to a low value (e.g. 1000).
For your network adapter, the way of setting the number of CPU interrupts may differ. You may, e.g., have to use a parameter to set a low number for the interrupt moderation and then use a different parameter to enable the interrupt moderation.
 - e. Select the parameter which relates to speed and duplex mode (e.g. **Speed and Duplex Mode**) and set it to auto (e.g. **Autonegotiation**).
4. If you have only one Fast Ethernet or non-compatible network adapter in the PC, the configuration for the filter driver is complete and you can close the Network Connections window and exit this procedure.

If you have more than one Fast Ethernet or non-compatible network adapter in the PC, return to step 1, select one of the other adapters, and perform steps 2 through 4 for each adapter.

Refer to the "Network Related Camera Parameters and Managing Bandwidth" section of your camera User's Manual for further adjustments of the network performance by setting additional network parameters for the network switch and the camera.

**Note**

If you use a firewall on your computer, disable the firewall for the network adapter to which your camera is connected.

For more information about disabling the firewall for network adapter(s), see Section 5.3.2 on [page 31](#).

5.3.2 Disabling the Windows Firewall

The Basler pylon software requires the Windows firewall to be disabled for all interfaces where cameras are connected to.



Managing the Windows Firewall

Microsoft has provided several interfaces to configure the Windows firewall:

- **netsh command line utility**
 - netsh firewall (Windows XP; not recommended for Windows Vista)
 - netsh advfirewall (Windows Vista only)

- **Traditional control panel**
(Windows XP and Windows Vista).

This is a relative simple firewall configuration tool.

- **Windows Firewall with advanced security settings**
(Windows Vista only):

These settings are more for a technically-inclined person. This advanced interface provides very granular firewall configuration options.

The management interface can be found under **Start > Control Panel > Classic View > Administrative Tools > Windows Firewall with Advanced Security**.

In the following the traditional control panel and the netsh command line utility are described.

To disable the Windows firewall via the traditional control panel

1. Open the **Windows Firewall** window:

Depending on your operating system realize one of the following procedures:

- Windows XP:
Start > Control Panel > Security Center > Windows Firewall
- Windows Vista:
Start > Control Panel > Security Center > Change Settings > Windows Firewall

On the **General** tab of the **Windows Firewall** window, the **On (Recommended)** option button can be selected. The disabling of the Firewall is realized on the **Advanced** tab.

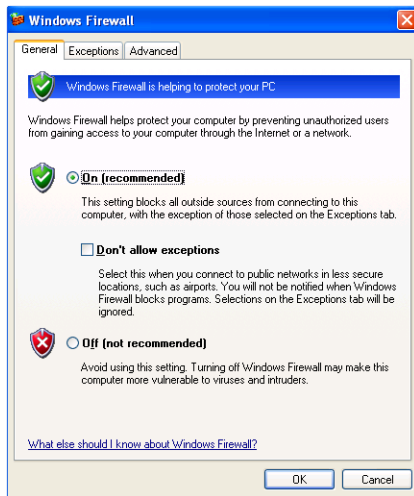

Note for Windows Vista

The **Off** option button on the **General** tab does not disable the firewall for all interfaces.

If you disable the firewall (on the **General** tab via the **Off** selection button), the firewall is only disabled for the current firewall profile (domain, private, public). If you have more than one network interface installed, you have to take care that all network interfaces are attached to the current profile.

2. On the **Advanced** tab:

In the **Network Connection Settings** group:

- Leave your companys network firewall enabled (see **Basler AG** in the following example).

- Deselect the checkbox for each connection where cameras are attached to (see **Local Area Connection 1** in the following example).

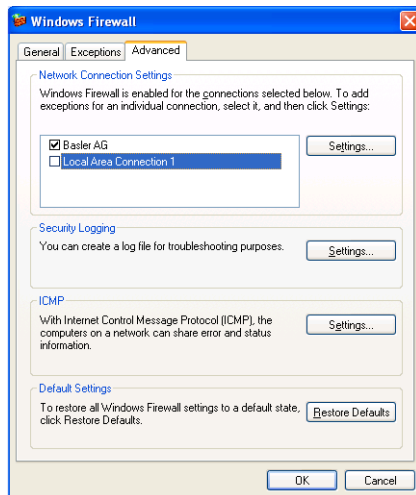

3. Click **OK**.

To disable the Windows firewall via command shell commands

Depending on your operating system realize one of the following procedures:

- For **Windows XP**
 - a. On the desktop, click **Start > Programs > Command Prompt**.
 - b. In the command shell window:
Enter `cmd` and press the **Enter** key.
 - c. To show all current interface names:
Enter `netsh interface show interface` and press the **Enter** key.
The command shell window displays a list of all interface names.
 - d. Realize the following step for all interfaces that you want to deactivate the firewall for:
Enter
`netsh firewall set opmode mode=disable interface="Interface Name"`
and press the **Enter** key.
"Interface Name" = one name from the list.

- For **Windows Vista**
 - a. On the desktop, click **Start > All Programs > Accessories > Command Prompt**.
 - b. In the command shell window:
 - Enter `cmd` and press the **Enter** key.
 - c. Enter `netsh advfirewall set allprofiles state off` and press the **Enter** key.
It is not possible to deactivate the firewall with netsh for one interface only.

5.4 Hardware Installation

NOTICE

Connecting power to an incorrect connector can damage the Camera.

1. Some camera models, like the scout and pilot, receive power via their 12-pin connectors. Other camera models, like the runner, receive power via their 6-pin connectors while their 12-pin connectors are exclusively reserved to I/O. Connecting power to the 12-pin connector of a camera like the runner, can damage the camera..

Do not connect power to the 12-pin connector of a camera like the runner.

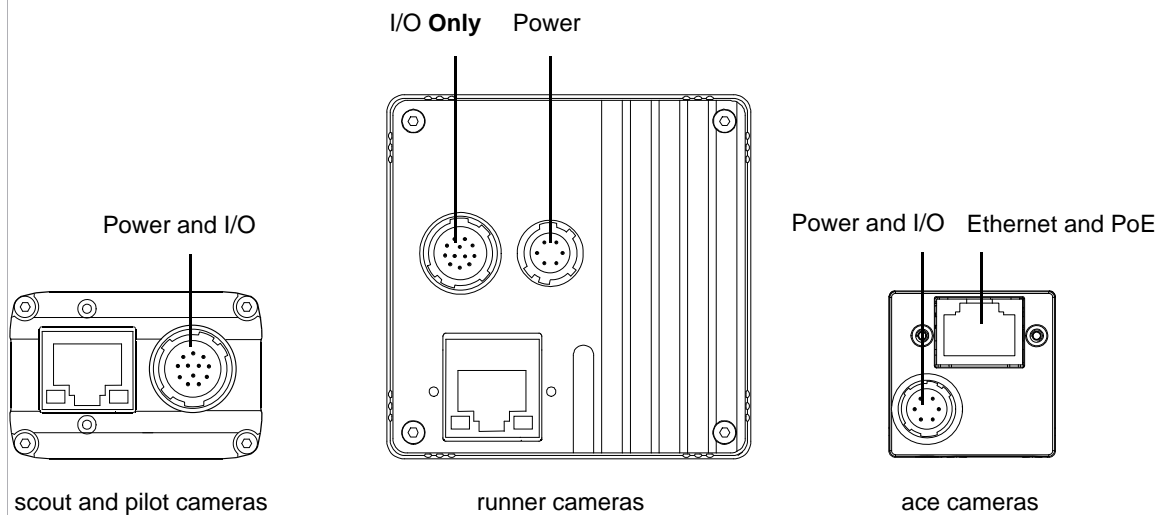

NOTICE

Voltage outside of specified range can damage the GigE Vision scout and pilot camera.

1. If the voltage of the power applied to the camera is greater than +24 VDC damage to the camera can result. If the voltage is less than 12 VDC, the camera may operate erratically..

NOTICE

Applying incorrect power can damage the runner camera.

1. The camera's nominal operating voltage is +12 VDC ($\pm 10\%$). If the voltage applied to the camera is greater than +13.2 VDC, severe damage to the camera can result. If the voltage is less than +10.8 VDC, the camera may operate erratically.
2. Make sure that the polarity of the power applied to the camera is correct. Applying power with the wrong polarity can result in severe damage to the camera.

NOTICE

Voltage outside of the specified range can damage the ace camera.

1. If you are supplying camera power via Power over Ethernet (PoE), the power must comply with the IEEE 1394 802.3af specification..
2. If you are supplying camera power via the camera's 6-pin connector and the voltage of the power is greater than +30.0 VDC, damage to the camera can result. If the voltage is less than +11.3 VDC, the camera may operate erratically.

NOTICE

An incorrect plug can damage the scout and pilot camera's 12-pin connector.

1. The plug on the cable that you attach to the camera's 12-pin connector must have 12 pins. Use of a smaller plug, such as one with 10 pins or 8 pins, can damage the pins in the camera's 12-pin connector.

NOTICE

Incorrect plugs can damage the runner camera's connectors.

1. The plug on the cable that you attach to the camera's 12-pin connector must have 12 female pins. Using a plug designed for smaller or a larger number of pins can damage the connector.
2. The plug on the cable that you attach to the camera's 6-pin connector must have 6 female pins. Using a plug designed for smaller or a larger number of pins can damage the connector.

NOTICE

An incorrect plug can damage the ace camera's 6-pin connector.

1. The plug on the cable that you attach to the camera's 6-pin connector must have 6 female pins. Using a plug designed for smaller or a larger number of pins can damage the connector.



If you use a firewall on your PC, deactivate the firewall for the network adapter to which your camera is connected.

To install the camera hardware, follow these steps:

1. Mount a C-mount or an F-mount lens, as applicable, onto your camera.
For C-mount lenses, make sure that the lens is screwed into the camera's lens adapter as far as it will go.
For F-mount lenses, make sure that the lens locks in place when you mount it onto the camera's lens adapter.
2. For scout, pilot, and runner cameras, and for ace cameras if you are not using PoE:
 - a. Plug one end of an Ethernet cable into the network adapter in your PC and the other end of the cable into the GigE connector on the camera.
3. For scout and pilot cameras:
 - a. Plug the 12-pin output connector from your power supply into the 12-pin connector on the camera.
 - b. Switch on the power supply.For runner cameras:
 - a. Plug the 6-pin connector on the cable from your power supply into the 6-pin connector on the camera.
 - b. Switch on the power supply.For ace cameras if you are not using PoE:
 - a. Plug the 6-pin connector on the cable from your power supply into the 6-pin connector on the camera.
 - b. Switch on the power supply.For ace cameras if you are using PoE:
 - a. Connect one end of a network cable to the network connector on the power injector labeled "Data In" and connect the other end of the cable to the network connector on the GigE network adapter in your PC.
 - b. Connect one end of the AC cable for the power injector to the injector's body and the other end to an AC outlet.
 - c. Connect one end of a network cable to the network connector on the power injector labeled "PoE Out" and connect the other end of the cable to the network connector on the camera.
4. The camera will start up and will go through an IP address assignment process. This takes about 60 to 90 seconds.
5. Once the IP assignment process is finished, the camera will be ready for use.

Note that if you have your system set so that a network connection icon appears in the system tray, you may see a yellow exclamation point on the icon. You may also see a message about limited connectivity as shown below. The message about limited connectivity is normal and this situation will have no effect on the camera. You can ignore this message.



5.5 Network Recommendations

This section describes the recommended adapters and architectures for the network to which your cameras are attached.

5.5.1 If You Are Using Multiple Network Adapters in a Single PC

With a typical installation of GigE cameras, the default network adapter settings will cause each adapter to use what is known as Automatic Private IP Addressing (APIPA) to assign itself an IP address. If you are using only one network adapter in your host PC, these adapter settings will work correctly with Basler GigE cameras that are set to default (e.g., new cameras coming out of the box).

However, if you have multiple network adapters in your PC and you will be connecting cameras to more than one adapter, this situation will cause a problem. The APIPA addressing scheme does not work correctly when it is used on more than one adapter.

The easiest way to avoid this problem when you are doing the initial camera installation and setup of your system is to change the adapter IP configuration settings and the camera IP configuration settings so that the cameras and the adapters will use fixed IP addressing. You should do this after you have completed the pylon software installation and you have followed the hardware installation procedure to connect the cameras to your adapters.

When you do the fixed IP addressing, keep in mind that each adapter in the PC must be assigned to a different subnet. Also keep in mind that all of the cameras attached to a single adapter must be on the same subnet as the adapter.

Be aware that if you are using a multiport network adapter in your PC, each port is considered to be a separate adapter.

For more information about changing the IP configuration of the cameras and the network adapters, see Section 5.6.2 on [page 48](#).

5.5.2 Recommended Network Adapters

The recommended network adapters for use with Basler GigE cameras are adapters of the Intel PRO 1000 series. The recommended adapters in the PRO 1000 series have been tested with the cameras and compatibility with these adapters is assured. These adapters are attractively priced and readily available.

Contact Basler technical support for recommendations of currently available PRO 1000 adapters and for information about compatible chipsets.

Network Adapters and the Basler Network Drivers

Although Basler recommends using PRO 1000 series adapters with our GigE cameras, the cameras will work with any Fast Ethernet (100 Mbit/s) or Gigabit Ethernet (1000 MBit/s) compatible network adapter card.

Two Basler network drivers are available, the Basler Filter Driver and the Basler Performance Driver.

If the adapter is a "non-compatible" adapter, i.e. the adapter you are using is not a PRO series adapter and does not have one of the Intel chipsets used in a PRO series adapter, you must install the Basler Filter Driver. Your camera will use the filter driver to communicate via the adapter. The advantage of the filter driver is that it will work with any Fast Ethernet or Gigabit Ethernet compatible adapter. (If you will be using the filter driver with your adapter, there is no need to install the performance driver.)

If you are using a "compatible" adapter, i.e. a PRO series adapter or an adapter that has one of the Intel chipsets used in a PRO series adapter ("compatible" chipsets), you can install the Basler Performance Driver. Your camera will use the performance driver to communicate via the network adapter. The advantage of the performance driver is that it requires significantly less CPU load to service the network communications between your camera and your PC. It also has a more robust packet resend mechanism.

For more information about installing the network drivers, see Section 5.2 on [page 24](#).

5.5.3 Recommended Network Architectures

Peer-to-peer Network Architecture

A strongly recommended network architecture is direct peer-to-peer connection between your cameras and your host PC. As shown in Figure 2, the cameras can be connected to individual gigabit network adapters in the host PC or to a multiport adapter in the PC.

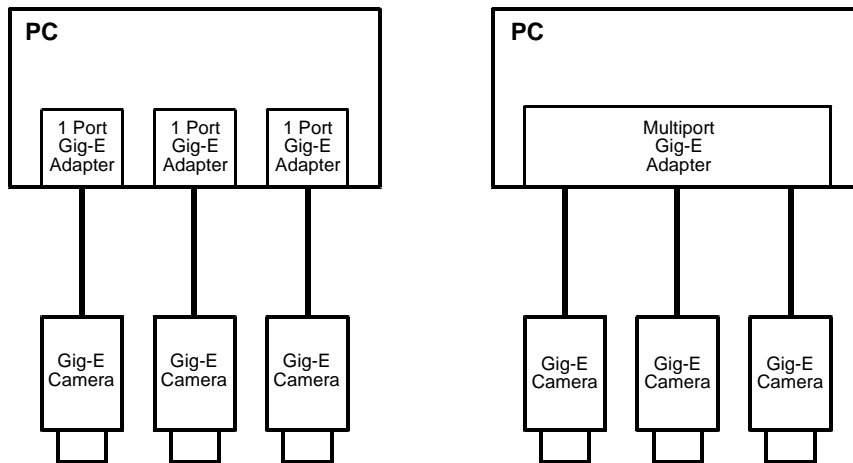

Fig. 2: Peer-to-peer Connections

The main advantage of the direct peer-to-peer architecture is that each camera has an individual connection to the host PC and thus each camera has the full connection bandwidth available for transmitting acquired images. This means that you can operate each camera at its full acquisition rate and not worry about sharing available network bandwidth between cameras.

The disadvantage of the peer-to-peer configuration is that it limits the number of cameras that can be connected to a single PC.

Connecting Via Network Switches

A second recommended network architecture involves connecting your cameras to the Gigabit Ethernet (GigE) adapter(s) in your host PC via network switches. As shown in Figure 3, the cameras can be connected to individual GigE network adapters in the host PC or to a multiport adapter in the PC. Note that the figure below only depicts simple schemes for connecting cameras to a PC via network switches.

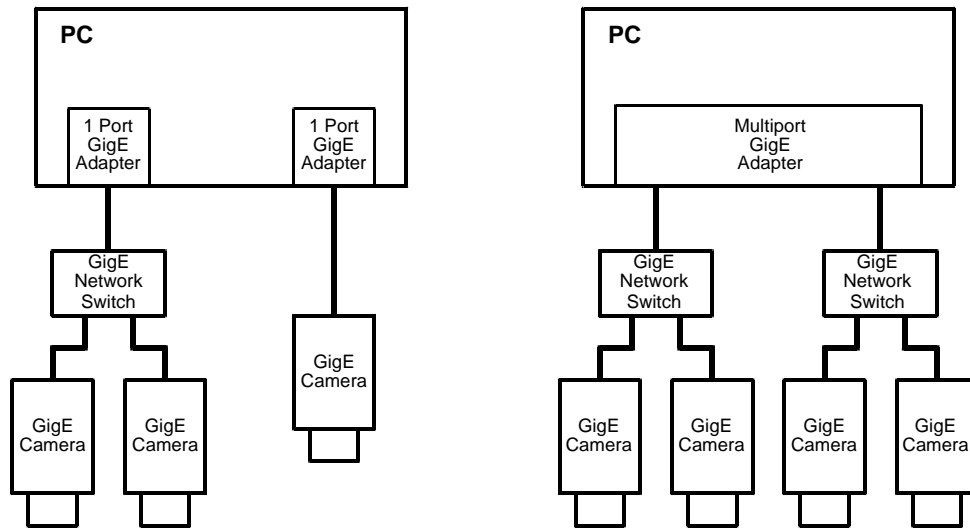

Fig. 3: Network Connections via Switches

One advantage of an architecture using switches is that it allows many cameras to connect to a single host PC. It also allows longer overall cable lengths because the cables between devices can each be up to 100 meters long.

The disadvantage of an architecture using switches is that the data from several cameras can end up passing through a single network connection and thus the cameras must share the bandwidth available on this single path. This situation is illustrated in Figure 4. The four cameras each have a connection to the network switch, but the switch only has a single connection to the PC. The four cameras must share the bandwidth available on the single path between the switch and the adapter. The bandwidth available on this single GigE path is about 125 MByte/s.

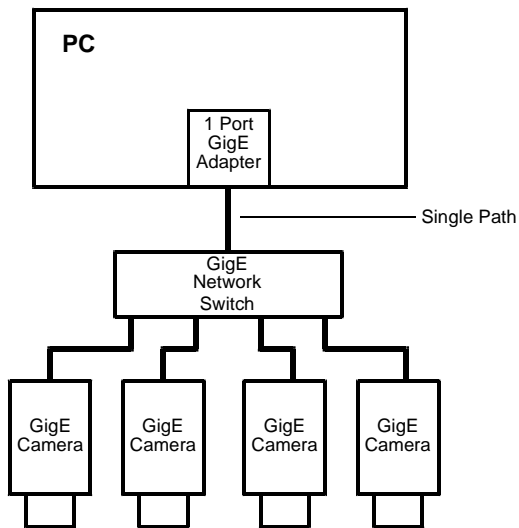

Fig. 4: Multiple Cameras Converging to a Single Path

For more information about managing network bandwidth when using multiple cameras on a single network path, see the "Basler Network Drivers and Parameters" section in the camera User's Manual.

Network Switch Issues

When selecting GigE network switches for use in the type of network described above, there are several issues you must keep in mind. First is that the switch must be able to handle large packets (also known as "jumbo packets" or "jumbo frames"). The typical maximum packet size on Ethernet devices used in the past was 1.5 kB. With newer "jumbo frame capable" devices, the maximum packet size can be up to 16 kB. Basler GigE cameras and the recommended Intel PRO 1000 adapters can both handle jumbo frames. For maximum network efficiency, your camera should be set to use the largest packet size that your network can handle. If you select a network switch that can only handle a small packet size, you will limit network efficiency.

A second issue involving the network switch is buffer capacity. In the situation where multiple cameras are attached to a switch, the switch must have enough buffer capacity to hold the incoming data from the cameras while it transmits the data out in an orderly fashion on the single outgoing line. In general, more buffer capacity is better.

PC Data Bus Issues

If you are connecting multiple cameras to your host PC, either through direct peer-to-peer connections or through network switches, you must be aware of the data bus type used in the PC. The PCI bus typical of older PCs is theoretically capable of handling 132 MByte/s of data. But in practice, the capacity of the PCI bus is lower and the bus bandwidth is shared by the network adapter and many other devices installed in the PC. To ensure adequate bandwidth on the PC's data bus, use of a PC with a PCI express data bus is recommended.

5.6 Camera and Network Adapter IP Configuration

This section describes the default IP configuration for your network adapter and camera. It also describes how to change the IP configuration on your camera and on your network adapter.



Note

This section of the user's manual assumes that you are familiar with basic Ethernet network concepts and with TCP/IP concepts such as IP addresses, subnet masks, and default gateways. If you are not, you should take some time to familiarize yourself with this basic information.

The following website provides comprehensive information about TCP/IP as it applies to Windows operating systems:

<http://www.microsoft.com/technet/network/evaluate/technol/tcpipfund/tcpipfund.mspx>

This section also assumes that you are familiar with using basic Windows operating system tools such as the Network Connections window to access your network adapter.

5.6.1 Network Adapter IP Behavior

The two most common ways to set the IP configuration on network adapters are:

- as "Fixed Address"
- as "DHCP / Alternate Configuration = APIPA (Automatic Private IP Addressing)"

When an adapter is set for Fixed Address, it will simply use a fixed address that has been assigned to the adapter by the user.

When an adapter is set for DHCP / Alternate Configuration = APIPA, it will do the following:

- It will first attempt to obtain an IP address from a Dynamic Host Configuration Protocol (DHCP) server. If a DHCP server is available, it will obtain an IP address from the server and use it.
- If no DHCP server is available, the adapter will use its alternate configuration. The alternate configuration will be for the adapter to use the Automatic Private IP Address routine to assign itself an IP address.

The default setting for most network adapters is DHCP / Alternate Configuration = APIPA. In most cases, the adapter used with your cameras will not have a DHCP server available. So with the default settings, the adapter will end up using automatic IP addressing to assign itself an IP address.



Note

There is another adapter IP configuration available called "DHCP / Alternate Configuration = Fixed Address", but this configuration is seldom used.

For more information about the Automatic Private IP Address routine, see the "Setting an Adapter to Use DHCP/Alternate Configuration = APIPA" section on [page 51](#)

5.6.2 Changing a Network Adapter's IP Configuration

5.6.2.1 Setting an Adapter to Use a Fixed IP Address

You can configure a network adapter to use a fixed IP address by doing the following:

1. Open the **Network Connections** window.
 - a. Find the connection for the adapter you want to configure. Right click on the name of the connection and select **Properties** from the drop down menu as shown below.

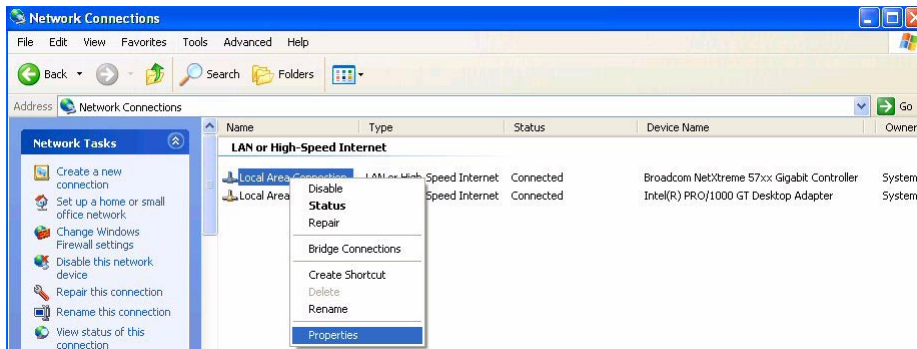

2. A **... Properties** window will open as shown below. Make sure that **Internet Protocol (TCP/IP)** is highlighted and click the **Properties** button.

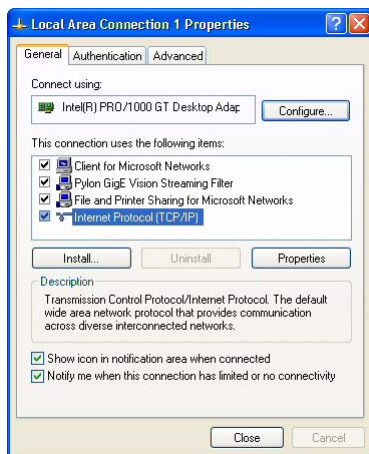

3. An **Internet Protocol (TCP/IP) Properties** window will open and the **General** tab will be selected as shown below.

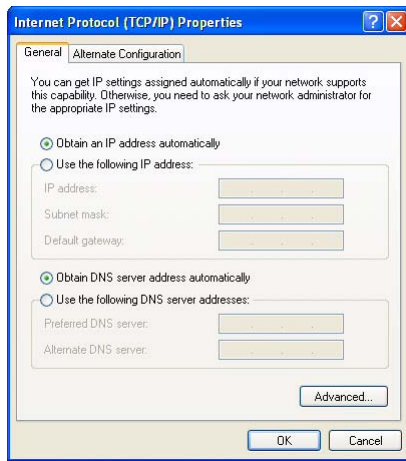

4. Click the radio button next to **Use the following IP address**. The window will change and will now allow you to enter IP address information.
- Enter your desired IP address and subnet mask. The figure below shows the window with typical values entered.
You can also enter a default gateway if desired, however, a default gateway is not normally needed.
 - If you will be using a domain name server (DNS), enter the appropriate information. (A domain name server is not normally needed.)
 - Click the **OK** button. The **Internet Protocol (TCP/IP) Properties** window will close.
 - Click the **Close** button on the **Local Area Connection Properties** window.
 - Your system will wait for several seconds while the new settings take effect. Once the new settings are in place, the **Local Area Connection Properties** window will close.



**Note**

When you configure an adapter to use a fixed address, there are some things that you must keep in mind:

- If your PC has multiple network adapters, each adapter must be in a different subnet.
- The recommended range for fixed IP addresses is from 172.16.0.1 to 172.32.255.254 and from 192.168.0.1 to 192.168.255.254. These address ranges have been reserved for private use according to IP standards.
- If you are assigning fixed IP addresses to your cameras, keep in mind that for a camera to communicate properly with a network adapter, it must be in the same subnet as the adapter to which it is attached.

**Tip**

There is a convenient "trick" that is handy during your initial camera design-in process or when working with cameras in your lab. You can set your network adapter to a fixed address in the automatic IP address range (169.254.0.0 to 169.254.255.255) with a subnet mask of 255.255.0.0 and you can set your camera(s) for automatic private IP address assignment (APIPA). With these settings, a camera and an adapter can establish a network connection very quickly. This can save you some time if you are connecting and disconnecting cameras or switching the system on and off as you would during design-in.

5.6.2.2 Setting an Adapter to Use DHCP/Alternate Configuration = APIPA

When a network adapter is set for DHCP / Alternate Configuration = APIPA, it will first try to find a DHCP server and to obtain an IP address from the server. If no DHCP server is available, the adapter will revert to the "alternate configuration." The alternate configuration will be for the adapter to use its built-in Automatic Private IP Address (APIPA) routine to assign itself an IP address.



Note

There is a limitation you must be aware of when set adapters to use Automatic Private IP Addressing (APIPA) as an alternate configuration. If a PC is equipped with multiple network adapters, APIPA can only be used on one of the adapters. If APIPA is enabled on more than one adapter, the network will not operate properly.

Note that if your PC is equipped with a multiport network adapter board, each port is considered to be the equivalent of a separate adapter. APIPA should be enabled on only one port.

You can configure a network adapter for DHCP / Alternate Configuration = APIPA by doing the following:

1. Open the **Network Connections** window.
 - a. Find the connection for the network adapter you are using with the camera. Right click on the name of the connection and select **Properties** from the drop down menu as shown below.

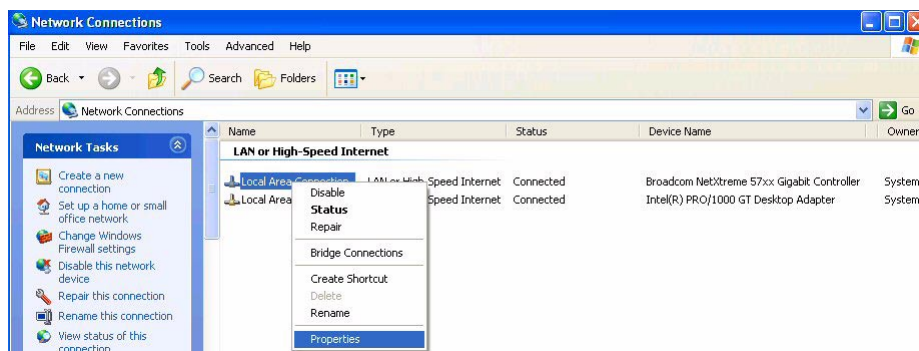

2. A **... Properties** window will open as shown below. Make sure that Internet Protocol (TCP/IP) is highlighted and click the **Properties** button.

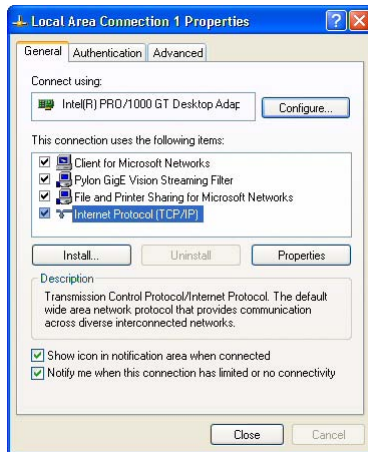

3. An **Internet Protocol Properties** window will open as shown below.
- On the **General** tab, make sure that the **Obtain an IP address automatically** radio button is selected. (This sets the adapter to check for a DHCP server as its first choice.)
If it is selected, go on to step 4.
 - If it is not selected:
Select the **Obtain an IP address automatically** radio button.
Click the **OK** button. A **Local Area Connection Properties** window will open.
On the **LAN Connection Properties** window, make sure that **Internet Protocol (TCP/IP)** item is highlighted and click the **Properties** button.



4. Click on the **Alternate Configuration** tab. The settings on this tab are used to set the alternate configuration that the adapter will use if no DHCP server is found.

- a. Select the **Automatic private IP address** radio button as shown below.

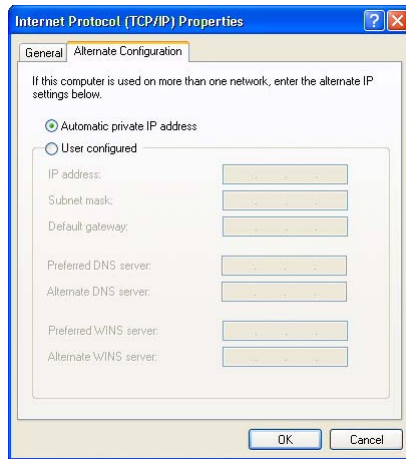

5. Click the **OK** button on the **Internet Protocol Properties** window.
6. Click the **Close** button on the **LAN Connection Properties** window.

5.6.2.3 Checking a Network Adapter's IP Address

You can check the current IP address of a network adapter by doing the following.

1. Open the **Network Connections** window.
2. Find the connection for the adapter you want to check and make sure that the status of the connection is shown as "connected" (if the status is "disconnected," this procedure will not work). Double click on the name of the connection.

A **LAN Connection Status** window will open as shown below.

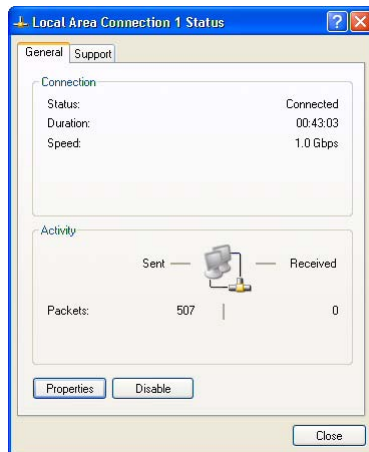

3. Click on the **Support** Tab. The IP address information for the adapter will be displayed as shown below.

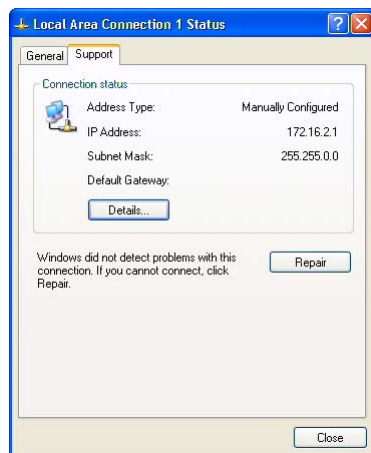

5.6.3 Camera IP Behavior

When a camera is powered on or reset, it exhibits the following behavior when it tries to connect to an Ethernet network:

- It checks to see if the camera has been configured to use a persistent (fixed) IP address. If the camera has a persistent IP address configured, it will use the persistent IP address.
- If no persistent IP address is configured, the camera will check to see if it is configured to use a Dynamic Host Configuration Protocol (DHCP) server to obtain an IP address and to see if a DHCP server is available. If the camera is configured to use a DHCP server and a DHCP server is available, the camera will obtain an IP address from the server.
- If no persistent IP address is configured and no address is obtained from a DHCP server, the camera will perform an Automatic Private IP Addressing (APIPA) routine and will assign itself an IP address.

Given this startup sequence, a new camera set to its default settings will do the following:

- The camera checks to see if it has been assigned a persistent (fixed) IP address. With the default settings, the camera is not assigned a persistent IP address. So no persistent address will be found.
- Because the camera does not have a persistent IP address assigned, it next checks to see if a DHCP server is available. Assuming that the camera is directly connected to a PC in peer-to-peer fashion, no DHCP server will be present. So an IP address will not be assigned to the camera by a DHCP server.
- Because the camera does not have a persistent IP address assigned and a DHCP server is not available, the camera will start an APIPA routine. When the routine is complete, the camera will be connected to the network and will have an auto-assigned IP address.

Note that the search for a DHCP server and the performance of an APIPA routine can take up to one minute to complete.

Automatic Private IP Addressing (APIPA)

The Automatic Private IP Address routine is a network standard that dictates how an IP address will be assigned to a network adapter and to the devices connected to the adapter when no other means of address assignment is available. In essence, the adapter or the device will assign itself an IP address in a range from 169.254.0.0 to 169.254.255.255 with a subnet mask of 255.255.0.0. As part of the routine, the network adapter and the devices attached to the adapter negotiate to make sure that there are no duplicate address assignments and that the adapter and the devices are all on the same subnet.



Note

For auto IP assignment to work correctly, the network adapter that the camera is plugged into must also be set for auto IP assignment or it must be set for a persistent address in the auto IP address range.



Note

If you have multiple network adapters in your PC, only one adapter can be set to use auto IP assignment. If more than one adapter is set to use auto assignment, auto assignment will not work correctly and the cameras **will not** be able to connect to the network.

In the case of multiple network adapters, it is best to assign persistent IP addresses to the adapters and to the cameras. You can also set the cameras and the adapters for DHCP addressing and install a DHCP server on your network.

The next sections in this chapter of the manual describe how to change the IP configuration on the cameras. See the earlier sections in this chapter for information about changing the IP configuration of network adapters.

5.6.4 Changing a Camera's IP Configuration

An application called the IP Configuration Tool is included as part of the pylon driver installation package. The IP Configuration Tool lets you make changes to the IP configuration of your camera.

To start the IP Configuration Tool:

- Double click the **pylon IP Configuration Tool** icon on your desktop
- Or click **Start**, click **All Programs**, click **Basler Vision Technologies**, click **Pylon x.x**, click **Pylon IP Configuration Tool**.

The tool will start and an **IP Configurator** window will open as shown below.

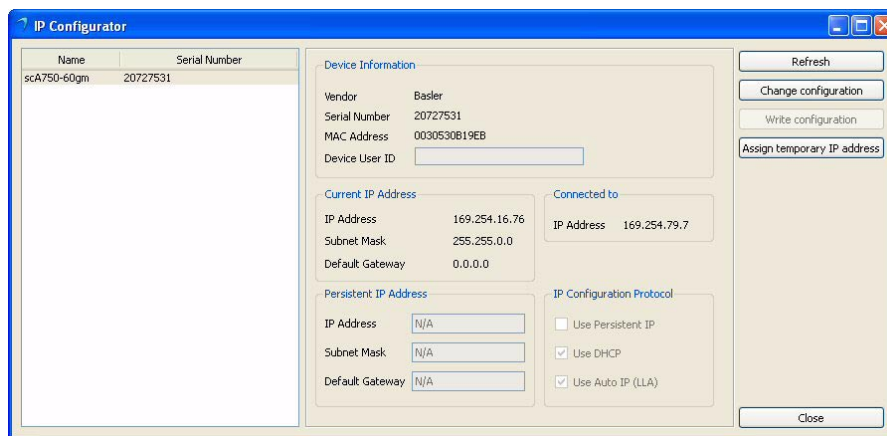

When the tool starts, it scans for cameras attached to the PC's network adapters. All cameras detected will be listed by model name and serial number in a box on the left side of the **IP Configurator** window. To select a camera to work with, click on its name in the list.

When you select a camera, the tool will display IP configuration and other basic information for the camera in various boxes:

- The **Device Information** box will display the Vendor's name, the Serial Number, the MAC address, and the Device User ID (if one has been assigned) for the selected camera.
- When the tool is in edit mode, the **Current IP Address** box will display the current IP Address, Subnet Mask, and Default Gateway for the selected camera. (When the tool is in list mode, this information is not available and N/A is displayed.)
- If the selected camera has a persistent (fixed) IP Address assigned to it, the **Persistent IP Address** box will display the current persistent IP Address, Subnet Mask, and Default Gateway.
- The **Connected to** box will display the IP Address for the network adapter to which the selected camera is connected.
- The **IP Configuration Protocol** box will display the current IP configuration of the selected camera.

If you would like to make sure that all of the displayed information is current, click the **Refresh** button. The tool will rescan the cameras and update the displayed information.

The IP Configuration Tool has two modes, List Mode and Edit mode:

- When the tool is first opened it is in **List** mode. In list mode, the tool can display a list of detected cameras, can display information about the camera selected in the list, and will let you assign a temporary IP address to the selected camera. When in list mode, the tool does not have a control channel open to any of the detected cameras. In list mode, the tool communicates with the cameras at a very low level.
- When the **Change Configuration** button is pressed, the tool will enter **Edit** mode. In edit mode, the tool will open a control channel to the selected camera. Once the control channel is open, the tool can make changes to things such as the selected camera's persistent IP address or Device User ID. Clicking the **Write Configuration** button takes the tool out of Edit mode and places it in List mode.

Assigning a Temporary IP Address to a Camera

You can use the IP Configuration Tool to assign a temporary IP address to a selected camera. Once a temporary IP address has been assigned to a camera, the camera will retain and use the temporary IP address until you do one of the following:

- Perform a camera reset or switch the camera off and back on.
- Assign a different temporary IP address to the camera.
- Use the tool to make permanent changes the camera's IP configuration.

A situation where you might want to assign a temporary IP address to a camera would be, for example, if you temporarily moved the camera from the PC where it is normally connected to another PC that is in a different subnet.

To assign a temporary IP address to a camera:

1. Click on the camera's name in the list at the left side of the **IP Configurator** window.
2. Click the **Assign Temporary IP Address** button.
3. An **Assign Temporary IP Address (Force IP)** window will open as shown below.
 - a. Enter your desired IP Address, Subnet mask, and Default Gateway.
(Keep in mind that for the camera to communicate properly with the network adapter to which it is attached, the camera must be in the same subnet as the adapter and the camera must have a unique IP address.)
 - b. Click the **OK** button.
 - c. The selected camera's current IP address will immediately be changed and the IP Configurator window will be updated to reflect the changes.

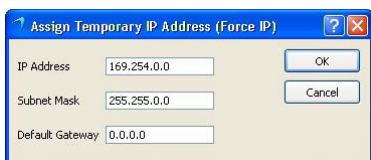

Making Changes to the Camera's IP Configuration

You can use the IP Configuration Tool to make permanent changes to the camera's IP configuration. (Permanent means that the changes will stay in place even when the camera is reset or switched off and back on.)

If you want to change the IP configuration of the camera:

1. Click on the **Change Configuration** button.
 - a. In some cases (such as when the camera's current IP address is misconfigured), a **Force IP** window will appear as shown below. The message in the window will indicate that you must first assign a temporary IP address. If you see this message, go to step 2.
 - b. If you do not see a message about assigning a temporary IP address, go to step 3.

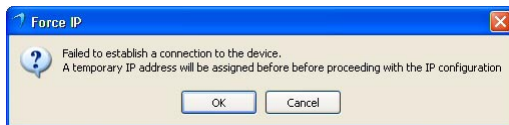

2. Click the OK button in the **Force IP** window. An **Assign Temporary IP Address (Force IP)** window will open as shown below.
 - a. Enter an IP Address, Subnet Mask, and Default Gateway. (If you are using the camera in a peer-to-peer network, you do not normally need to enter a default gateway.)
(Keep in mind that for the camera to communicate properly with the network adapter to which it is attached, the camera must be in the same subnet as the adapter and the camera must have a unique IP address.)
 - b. Click the **OK** button.
 - c. The camera's IP address will be changed and the **Assign Temporary IP Address (Force IP)** window will close.
 - d. Go on to step 3.

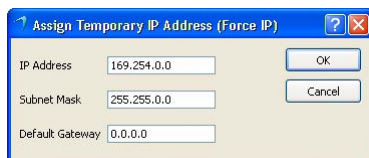

3. The **IP configurator** window will enter edit mode and will now allow you to enter new IP values as shown below.
 - a. If desired, enter a Device User ID for the camera.
 - b. If you want to assign the camera a persistent (fixed) IP address, enter an IP address, a subnet mask, and a default gateway.
Also make sure that the **Use Persistent IP** check box is checked.
(Before you assign a persistent IP address, you should read the notes that appear in the note at the end of this procedure.)
 - c. If you want the camera to use DHCP address assignment (i.e., to obtain an IP address from a DHCP server attached to the same network as the camera), make sure that the **Use DHCP** check box is checked and that the **Use Persistent IP** check box is **not** checked.

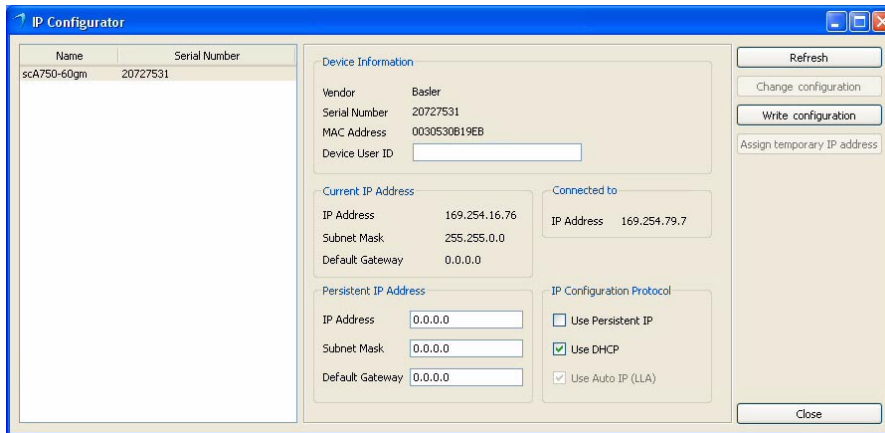

- When you are finished making changes, click the Write Configuration button.

A message will appear indicating that the camera is restarting its IP configuration cycle as shown below. When this message disappears the changes to the IP configuration will be in place and the **IP Configurator** window will now show the changed settings.

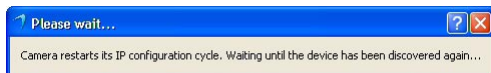

Note

When you configure a camera to use either a temporary or a persistent address, there are some things that you must keep in mind:

- For a camera to communicate properly, it must be in the same subnet as the adapter to which it is connected.
- The camera must have an IP address that is unique within the network.
- The recommended range for persistent IP addresses is from 172.16.0.1 to 172.32.255.254 and from 192.168.0.1 to 192.168.255.254. These address ranges have been reserved for private use according to IP standards.
- If your PC has multiple network adapters, each adapter must be in a different subnet.

5.7 Modifying the Installation

5.7.1 Changing the Driver Association for a Compatible GigE Network Adapter

During installation of the Basler pylon Driver Package, the current network adapter-driver associations are changed for **all** compatible network drivers installed in your PC. The Basler performance driver will replace the current drivers.

If you want to reestablish a network adapter-driver association with the original driver, follow the procedures below. The procedures describe how to change the driver on a GigE network adapter from the Performance Driver back to the original driver.

1. Open a **Network Connections** window. Make sure that the window is set to display details (right click within the window, select **View**, and select **Details**).
2. Find the entry for the network adapter whose association you want to change. When moving the pointer over the name of the network adapter, notice that the tooltip indicates **Basler GigE Vision Adapter**.
3. Right click on the name of the network adapter.
4. Select **Properties** from the drop down menu. A **LAN Connection Properties** window for the adapter will open.
5. Click the **Configure** button.
6. Select the **Driver** tab.
7. Click the **Update Driver** button.
8. When the hardware wizard opens, select **No, not this time** and click the **Next** button.
9. Select **Install from a list or specific location (Advanced)** and click the **Next** button.
10. Select **Don't search, I will choose the driver to install** and click the **Next** button.
11. From the list that appears, select the original driver for the adapter (e.g., in a case where the Intel PRO 1000 GT Desktop Adapter is installed in the PC, select **Intel PRO 1000 Desktop Adapter** from the list) and click the **Next** button.
12. The system will update the driver. Click the **Finish** button.
13. Close the **Properties** window.
14. In the **Network Connections** window, notice that the Device Name for the adapter has changed (in the case of the Intel PRO 1000 GT, it will now be **Intel PRO/ 1000 GT Desktop Adapter**).

The network adapter-driver association is changed.

5.7.2 Unbinding the Basler Filter Driver from a Network Adapter

During installation of the Basler pylon Driver Package, the Basler filter driver will be bound as a service to **all** network drivers installed in your PC. For non-compatible and Fast Ethernet network adapters, the service will be enabled and the previous network drivers will become deactivated. For compatible network adapters, which will be associated with the Performance driver, the service will not be enabled.

We recommend unbinding the Basler filter driver from network adapters that are not used for a camera and from compatible network adapters that are used with the Basler performance driver.

As an example, the following procedures describe how to unbind the Basler filter driver from a Fast Ethernet (or non-compatible GigE) network adapter:

1. Open a **Network Connections** window. Make sure that the window is set to display details (right click within the window, select **View**, and select **Details**).
2. Find the entry for the network adapter from which you want to unbind the Basler network driver.
3. Right click on the name of the network adapter.
4. Select **Properties** from the drop down menu. A **LAN Connection Properties** window for the adapter will open.
5. Look for the list box in the middle of the window that is labelled **This connection uses the following items**.
6. In the list, find the entry for **Pylon GigE Vision Streaming Filter** and uncheck the entry.
7. Click the **OK** button.
8. The driver will be unbound and the **Properties** window will close.

The Basler network driver is unbound.



Note

You could completely uninstall the Basler filter driver by clicking on its entry in the list and then clicking the **Uninstall** button. Be aware that doing so will remove the Basler filter driver from all network adapters

5.7.3 Modifying Your Software Installation

You can install a software feature that you initially had deselected during the installation or remove a software feature that you initially installed, any time you want.



Note

The software feature to be installed must have the same version number as the Basler pylon software currently installed on your PC.

If in doubt, obtain the latest version of Basler pylon software and install it.

1. Make sure your camera is disconnected from your computer.
2. Use the Windows Add or Remove Programs function to add or remove a software feature:
 - Windows XP: **Start > Control Panel > Add or Remove Programs**
 - Windows Vista: **Start > Control Panel > Programs > Programs and Features**

6 Installing an IEEE 1394 Camera

6.1 General Considerations

Make sure the following items are available before starting installation:

- A Basler scout IEEE 1394b camera.
- A C-mount lens.

If you already know what lens to use, use this lens. Otherwise, we suggest that you use a zoom lens for initial setup. Contact Basler technical support if you need assistance in determining the best lens for your application. The contact numbers appear in the title pages of this manual.

- A desktop or laptop computer with an appropriate operating system (see the "System Requirements" section).
- Basler pylon Software:

You can download the Basler pylon Driver Package at: www.baslerweb.com.

- An IEEE 1394 adapter installed on the computer.

If you use a desktop computer with an IEEE 1394 adapter, make sure the adapter is configured to supply between +8 and +36 VDC to the camera. Also make sure the adapter can supply at least the required power to the camera. Refer to the specification table in the first section of this manual for more information about camera power consumption. For example, 2.5 W are typically required for the scA640-70fm/fc at 12 VDC.

If you use a laptop with an IEEE 1394 connector, note that on almost all laptops, it will be an IEEE 1394a connector. Also note that most laptops **do not** supply power via the IEEE 1394 connector. In this case you must do **either** of the following:

- Use a powered hub between the laptop and the camera, and make sure that the hub can supply the required power to the camera.
- Install a PCMCIA IEEE 1394 adapter card in the laptop that connects to an external power supply, and make sure that the power supply can supply sufficient power to the camera.

NOTICE

Voltage outside of specified range.

1. If the voltage of the power to the camera is greater than +36 VDC, damage to the camera can result. If the voltage is lower than +8 VDC, the camera may operate erratically.

Make sure that you keep the voltage between +8 and +36 VDC.

- IEEE 1394 cables.

To connect an IEEE 1394b camera to an IEEE 1394b adapter, a standard, 9-pin shielded IEEE 1394b to 1394b cable should be used. The maximum length between the camera and the computer or the hub is 4.5 m.

If you want to connect the camera to an IEEE 1394a device, as applies to most laptops, you must use a conversion cable. The cable will have a 9-pin IEEE 1394b plug on the end that connects to the camera and a 6-pin IEEE 1394a plug on the end that connects to the computer or the powered hub.

Figure 5 shows a variety of ways that an IEEE 1394b camera can be connected to an IEEE 1394 adapter in a computer. Refer to the figure and plan your cabling needs now.

NOTICE

Incorrect power polarity.

Reversing the polarity of the power will damage the camera.

1. To avoid reversing the polarity, use only standard IEEE 1394 cables.

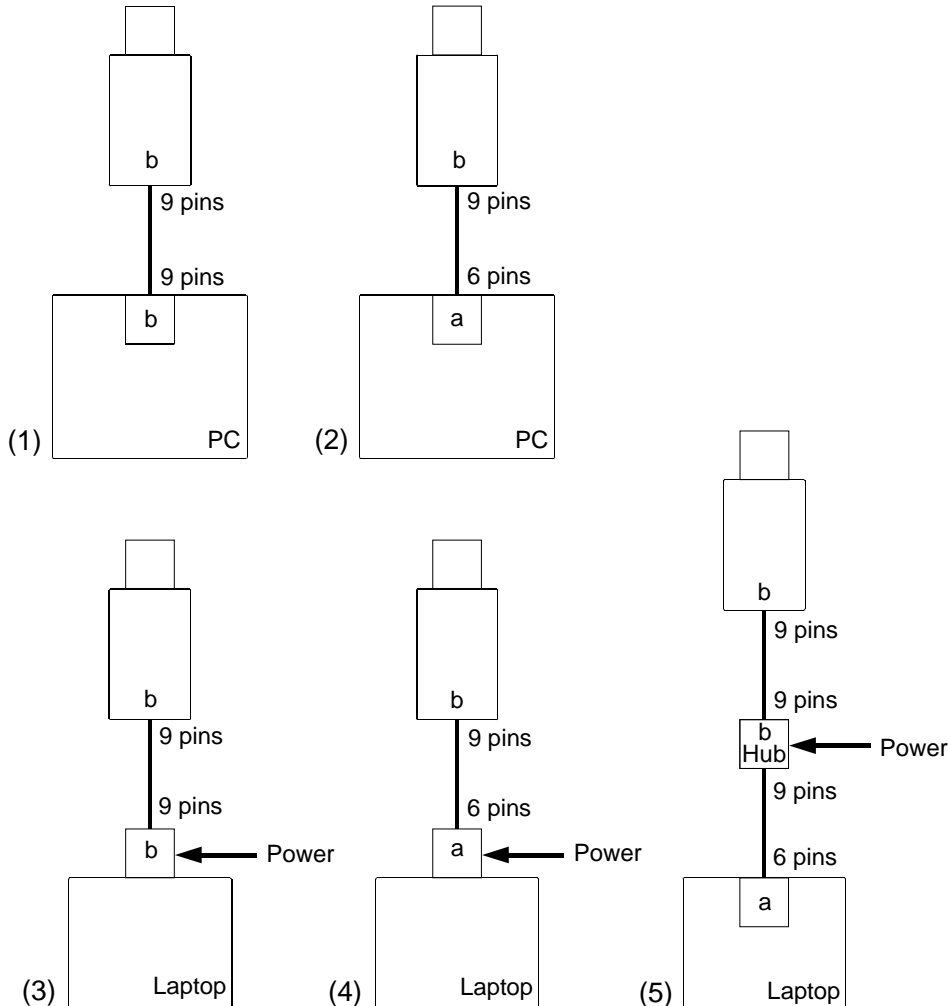

Fig. 5: Different Ways to Connect an IEEE 1394b Camera to a Computer

- (1) Camera linked to a PC equipped with an IEEE 1394b compliant adapter. The camera receives power from the PC. Required cable: 1394b to 1394b.
- (2) Camera linked to a PC equipped with an IEEE 1394a compliant adapter. The camera receives power from the PC. Required cable: 1394b to 1394a.
- (3) Camera linked to a laptop computer equipped with a powered IEEE 1394b compliant adapter card. The camera receives power from the card. Required cable: 1394b to 1394b.
- (4) Camera linked to a laptop computer equipped with a powered IEEE 1394a compliant adapter card. The camera receives power from the card. Required cable: 1394b to 1394a.
- (5) Camera linked to a powered IEEE 1394b compliant hub which is linked to a laptop computer with an IEEE 1394a compliant adapter. The camera receives power from the hub. Required cables: 1394b to 1394b and 1394b to 1394a.

6.1.1 Installation Procedure

Go through the software installation procedure in this manner:

- First, go to the "Installing the Basler pylon Software" section and install the software.
- Next, go to the "Associating a IEEE 1394 Camera Driver with Your Camera" section, check which IEEE 1394 camera driver is currently associated with your camera, and change the association if necessary. If you are using multiple IEEE 1394 cameras with your PC, repeat this step for each IEEE 1394 camera.

6.2 Software and Hardware Installation

6.2.1 Installing the Basler pylon Software



Note

During installation of the Basler pylon 1394 camera driver, the current camera-driver associations may be changed.

Depending on the conditions before and during installation, you will find your IEEE 1394 camera associated after the installation with one of the following camera drivers:

- generic 1394 desktop camera driver
- Basler BCAM 1394 camera driver (from a previous installation of BCAM software)
- Basler pylon 1394 camera driver

For information on checking and, if necessary, changing the current camera-driver association, see the "Associating an IEEE 1394 Camera Driver with Your Camera" section.

For the installation, choose the appropriate name of the installer from [Table 2](#), depending on the operating system of your PC.

You can obtain the Basler pylon Driver Package as a download from the Basler website: www.baslerweb.com.

	32 bit Operating System	64 bit Operating System
Basler pylon Driver Package	Basler pylon SDK 86 x.x.x.xxx.exe	Basler pylon SDK x64 x.x.x.xxx.exe

Table 2: Installer Names

1. Make sure that all IEEE 1394 cameras are disconnected from your computer.
2. Download the installer from the Basler website (www.baslerweb.com) to a local directory of your computer (for possible installer names, see [Table 2](#)).
3. Launch the downloaded executable.

The program will prepare to install and then a **Welcome** window will open.

4. Click the **Next** button.

A **License Agreement** window will open.

5. Accept the agreement and click the **Next** button.

A **Customer Information** window will open.

6. Enter the appropriate information and click the **Next** button.

7. In the **Destination** window determine the directory where you want to install the software to and click the **Next** button.

A **Custom Setup** window will open.

- d. Deselect the features of the pylon software that you do not want to install.

- e. Only select those features of the pylon software you want to install.

The example shown below assumes that you will only use IEEE 1394 cameras, and that your applications and software development only use C++.

See the "pylon Software Features and General Recommendations for Selection" section for information about the software features and recommendations about combining software features for installation.

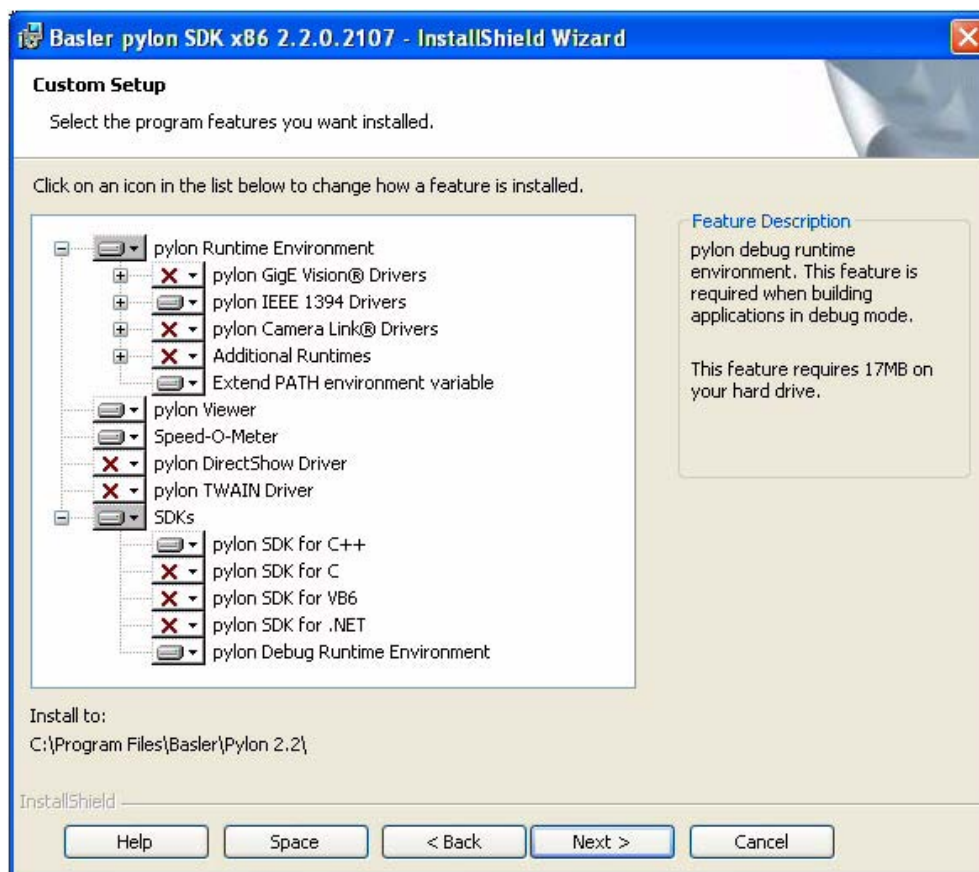

**Note**

The deselected features will not be installed. They will, however, be saved on your PC. Therefore, if you want to install them later, you can easily install them from your PC.

For more information, see the "Installing a Software Feature" section.

8. Click the **Next** button.
9. A **Ready to Install the Program** window will open.

**Note**

Before proceeding, close all applications needing a network connection. Otherwise, the network connections for your applications will temporarily be lost.

10. Click the **Install** button.
When the installation process is complete, a **Completed** window will open.
11. Click the **Finish** button.
12. An **Installer Information** window may open informing about the need to restart the computer.
 - If you want to restart the computer now, click the **Yes** button.
 - If you want to restart the computer later, click the **No** button.If the **Installer Information** window does not open, there is no need to restart the computer.
Note that the installation program has added shortcuts to the desktop.
13. To see the installed software features:
Click **Start > All Programs > Basler Vision Technologies > Pylon 2.2**.

The Basler pylon software installation is complete.

**Note**

In general each additional camera is automatically associated with the driver. If this is not the case, associate the camera driver manually with the camera.

6.2.2 Associating an IEEE 1394 Driver with Your Camera

The following procedures assume that you have Basler pylon software installed on your PC, including the Basler pylon 1394 camera driver.

1. Open a **Device Manager** window by doing the following:
 - a. Click **Start** and click **Run**.
 - b. When the **Run** window opens, type in: `devmgmt.msc`
 - c. Click the **OK** button.
 - d. The **Device Manager** window will open and will display a list of device classes as shown below.

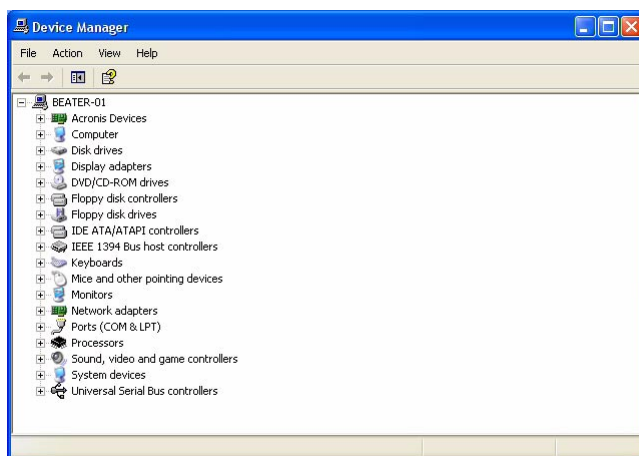

2. Get **one** of your IEEE 1394 cameras and do the following:
 - a. Make sure your camera is connected to an IEEE 1394 adapter in the computer.
 - b. Wait for the device manager to detect the camera.
(This process can take several minutes. While the process is going on, you may see the list of device classes in the window open and close several times.)
3. Once detection is complete, find the listing for the camera in the device manager to check the current camera-driver association.

If the camera has never been attached to your computer, you should now find a device class called **Imaging Devices**. When you click the plus sign beside **Imaging Devices** you will find a listing for a **Generic 1394 Desktop Camera**. This situation indicates that the system detected the camera and associated it with a generic 1394 camera driver.

If the camera has been attached to your computer before and you used Basler's BCAM driver, you may find a device class called **Basler 1394 Digital Cameras**. When you click the plus sign beside **Basler 1394 Digital Cameras**, you will find a listing for a **Basler XXX BCAM digital camera** (where XXX is a camera name). This situation indicates that the system detected the camera and associated it with Basler's BCAM camera driver.

If the camera has been attached to your computer before and you used an older version of the Basler pylon 1394 camera driver, you may find a device class called **Basler pylon 1394 Digital Cameras**. When you click the plus sign beside **Basler pylon 1394 Digital Cameras**, you will find a

listing for a **Basler XXX digital camera** (where XXX is a camera name). This situation indicates that the system detected the camera and associated it with Basler's pylon 1394 camera driver. This driver will be the **new version** of the Basler pylon 1394 camera driver that was updated during the preceding installation of the Basler pylon software.

4. If you are satisfied with the current camera-driver association, go to step 11.
If you want to change the current camera-driver association, do the following:
 - a. Right click on **Generic 1394 Desktop Camera**, on **Basler XXX BCAM digital camera** or on **Basler XXX digital camera** (whichever one you saw in step 3.)
 - b. select **Update Driver** from the drop down menu that appears.
5. A **Hardware Update Wizard Welcome** window will open.
 - a. Select **No, not this time**.
 - b. Click the **Next** button
6. A **Hardware Update Wizard** window will open asking if you want to install automatically or from a specific location.
 - a. Select **Install from a list or specific location**.
 - b. Click the **Next** button.
7. A **Hardware Update Wizard** window will open asking you to choose your search and installation options.
 - a. Select **Don't search. I will choose the driver to install**.
 - b. Click the **Next** button.
8. A **Hardware Update Wizard** window will open asking you to select the driver you want to install with your hardware.

Assume in this and the following steps, for example, that you want to change the current camera-driver association to the association with the Basler pylon 1394 camera driver:

In the list box of the **Hardware Update Wizard** window, you should now see the model name of your camera followed by "(pylon)". For example, if you attached an scA640-70fm, you should see "scA640-70fm (pylon)" as shown below.

- a. Click on the model name to highlight it.
- b. Click the **Next** button.

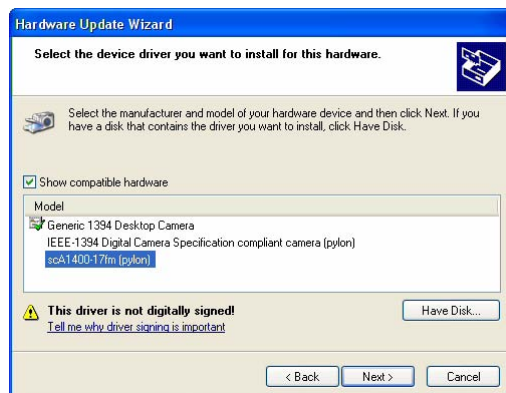

9. The pylon 1394 camera driver will be associated with the camera. When the process is complete, a **Completing Hardware Update** window will open. Click the **Finish** button.

10. Notice that your camera is now listed (by model name) under the **Basler pylon 1394 Digital Cameras**. Any device listed under the **Basler pylon 1394 Digital Cameras** device class is associated with the Basler pylon 1394 driver.

If there are multiple cameras of the same model listed under the device class, they will be listed by the model name followed by "camera 1", "camera 2", etc.

Click the **Cancel** button to close the **Hardware Update Wizard** window.

11. If you use only one IEEE 1394 camera with your computer, your IEEE 1394 camera is now associated with the desired camera driver. You can close the **Device Manager** window and exit this procedure.

If you use more than one IEEE 1394 camera with your computer, perform steps 2. through 10. for each IEEE 1394 camera.

6.2.3 Modifying Your Software Installation

You can install a software feature that you initially had deselected during the installation or remove a software feature that you initially installed, any time you want.



Note

The software feature to be installed must have the same version number as the Basler pylon software currently installed on your PC.

If in doubt, obtain the latest version of Basler pylon software and install it.

1. Make sure your camera is disconnected from your computer.
2. Use the Windows Add or Remove Programs function to add or remove a software feature:
 - Windows XP: **Start > Control Panel > Add or Remove Programs**
 - Windows Vista: **Start > Control Panel > Programs > Programs and Features**

7 Installing a Camera Link Camera

7.1 General Considerations

The installation procedures assume that you will be making a peer-to-peer connection between your camera and a frame grabber installed in a desktop computer. Make sure that the following items are available before starting the installation:

- A Basler aviator camera.
- A power supply for the camera. Make sure that the power supply meets all of the requirements listed in the camera User's Manual.
- A C-mount lens for the camera.

If you already know what lens you will be using in your actual application, use this lens during the camera installation and setup. If not, we suggest that you use a zoom lens for your initial installation and setup. Contact Basler technical support if you need assistance in determining the best lens for your application. The support contact numbers appear in the title pages of this manual.

- A PC equipped with a Camera Link frame grabber. The frame grabber must support at least the base Camera Link configuration. It also must be able to handle a camera with a 65 MHz Camera Link pixel clock.

The desktop computer must be equipped with an appropriate operating system (see the "System Requirements" section).

- A appropriate AC power cable (see the camera User's Manual).
- An appropriate Camera Link cable (see the camera User's Manual)
- An appropriate cable for connecting the camera's I/O lines (see the camera User's Manual)
- Basler pylon Software:

You can download the Basler pylon Driver Package at: www.baslerweb.com.

You should perform the hardware installation procedure first and the software installation procedure second.



The pylon software package for use with Camera Link cameras is only available for 32 bit operating systems.

Note: Only Basler aviator Camera Link cameras are supported.

NOTICE

If the voltage of the power to the camera is greater than +13.2 VDC, damage to the camera can result. If the voltage is less than +10.8 VDC, the camera may operate erratically.

Applying power with the wrong polarity can result in severe damage to the camera.

1. Always make sure that the voltage of the power to the camera is within the specified range.
2. Always make sure that the polarity of the applied voltage is correct.

NOTICE

Incorrect plugs can damage the camera's connectors.

1. The plug on the cable that you attach to the camera's 12-pin connector must have 12 female pins. Using a plug designed for a smaller or a larger number of pins can damage the connector.
2. The plug on the cable that you attach to the camera's 6-pin connector must have 6 female pins. Using a plug designed for a smaller or a larger number of pins can damage the connector.

NOTICE

Making or breaking connections incorrectly can damage the camera.

1. Be sure that all power to your camera and to your host PC is switched off before you make or break connections to the camera. Making or breaking connections when power is on can result in damage to the camera or to the frame grabber.
2. If you can't switch off the power, be sure that:
 - a. The input power plug is the last connector that you plug into the camera when making connections.
 - b. The input power plug is the first connector that you unplug from the camera when breaking connections.

NOTICE

On color cameras, the lens thread length is limited.

1. Color models of the camera with a C-mount lens adapter are equipped with an IR cut filter mounted inside of the adapter. The location of this filter limits the length of the threads on any lens you use with the camera. If a lens with a very long thread length is used, the IR cut filter will be damaged or destroyed and the camera will no longer operate. Do not use a lens with a thread length greater than 7.5 mm.

7.2 Frame Grabber Preparations

The following procedures assume that you have installed a Camera Link frame grabber in your PC, that you have properly installed all software included with the frame grabber, and that you understand how your frame grabber operates.

To correctly use a Camera Link camera, you must be thoroughly familiar with the operation of your frame grabber.

All aviator camera models have a default Camera Link clock speed of 65 MHz, however, not all frame grabbers are compatible with a clock speed this high. You should check the documentation for your frame grabber and make sure that it can operate at a 65 MHz pixel clock speed. If it cannot, the clock speed on the camera can be changed to 32.5 MHz, 40 MHz, or 48 MHz. For more information about changing the Camera Link pixel clock speed, see the camera User's Manual.

7.2.1 Location of the Serial Port File

All Camera Link compliant frame grabbers must be supplied with a dll file which describes the characteristics of a serial port that is built into the frame grabber. This serial port is used for communication between your PC and your camera via the Camera Link interface.

The name of the file supplied by the frame grabber manufacturer will have the form `clser***.dll` where `***` is determined by the manufacturer of the grabber and usually represents the manufacturer's name. For example, a frame grabber made by the "Acme" company may supply a file called `clseracm.dll`. The frame grabber software should take care that this file is located correctly for the PC-to-camera communication via the serial port. If no communication can be established, check whether the `clser***.dll` file is located at the path specified by the Windows registry key **HKEY_LOCAL_MACHINE\SOFTWARE\CameraLink\CLSerialPath**. If the `clser***.dll` file is not at this location, copy it there.



Version 2.2 of the pylon package only supports 32 bit `clserxxx.dll` files.

7.2.2 Frame Grabber "Camera Files"

For your camera to operate properly with your frame grabber, you must install the correct frame grabber "camera file." In essence, the camera file informs the frame grabber about how the pixel information coming from the camera will be ordered and about the bit depth of the pixel data.

Depending on the frame grabber supplier, there can be a separate camera file for each combination of camera model and pixel data format or a camera file may cover several different camera models.

Typically, each frame grabber supplier has a different naming scheme for their camera files. For example, Matrox refers to the camera files for their grabbers as "Digital Configuration Files" or DCF files and National Instruments refers to theirs as "Interface Camera Descriptors" or ICD files.

Camera files appropriate for the aviator must be supplied by your frame grabber manufacturer. If you don't have the camera files for your frame grabber, you can usually find them at the supplier's web site.

Once you have the camera files, there are three things you must keep in mind:

- The camera file that you obtain and install must be appropriate for the pixel data format setting that you will be using on your camera. Refer to the camera user's manual for information about available pixel data formats.
- The camera file must be installed in the correct location on your PC. This location varies depending on your frame grabber supplier. Consult the documentation for your frame grabber to determine where the camera files should be installed.
- The camera must be set for your desired pixel data format. You can set the camera's pixel data format using the pylon software you will be installing later in this guide.

7.3 Hardware Installation

To install the camera hardware, follow these steps:

1. Make sure that your camera power supply is not connected to the camera and that the power to your host PC is switched off.



In the following step, you will be removing the dust cap from the camera's lens mount. To avoid collecting dust or dirt on the imaging sensor, be sure that the lens mount is pointing down when you remove the cap.

2. Remove the cap from the lens mount on the camera and mount a lens on the camera.
3. Mount the camera in your test setup.
4. Plug one end of a Camera Link cable into the MDR connector on the camera and the other end of the Camera Link cable into the connector on your frame grabber that is designated as the base configuration connector.

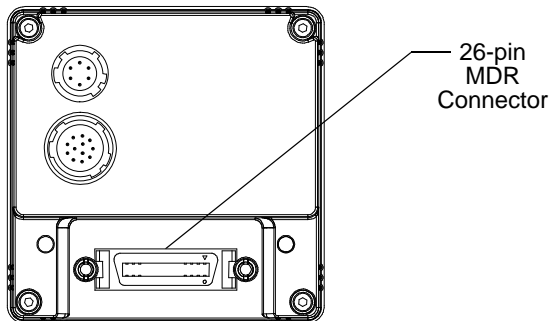

5. Make sure that the connectors on the cable are securely fastened to the camera and to the frame grabber. **If the connectors are loose, they WILL cause problems with your images.**
6. Switch on the power to your host PC and let the PC boot up.
7. If you obtained the power supply for your camera directly from Basler:
 - a. Connect the plug on the power supply's output cable to the 6-pin power connector on the camera.
 - b. Plug the power supply into an AC outlet.

If you are using a power supply that was not obtained from Basler:

- a. Refer to the Interface chapter in your camera user's manual and locate the information regarding the camera input power. Make sure that your power supply can meet the input power requirements.
- b. In the Interface chapter, locate the information regarding the power connector on your camera. Make sure that the output cable on your power supply is correctly wired and that the cable is terminated with the proper type of plug. **If the cable is miswired or the incorrect plug is used, severe damage to the camera can result.**
- c. Connect the plug on the power supply's output cable to the 6-pin power connector on the camera.
- d. Plug the power supply into an AC outlet.

Hardware installation is complete. Continue with the software installation procedure.

7.4 Basler pylon Software Installation

For the installation, choose the appropriate name of the installer from [Table 3](#), depending on the operating system of your PC.

You can obtain the Basler pylon Driver Package as a download from the Basler website: www.baslerweb.com.

	32 bit Operating System	64 bit Operating System
Basler pylon Driver Package	Basler pylon SDK 86 x.x.x.xxx.exe	N/A (Not available for Camera Link cameras).

Table 3: Installer Names

Once you have downloaded the software package, you can install the software by doing the following:

1. Close all open Windows based applications on your computer. **We most strongly recommend that you close all open applications now.**
2. Click **Start**, click **Run**, and click the **Browse** button.
3. Navigate to the location where you downloaded the pylon software installation package, select the installation package, click the **Open** button, and click the **OK** button.
4. The program will prepare to install and then a **Welcome** window will open.
Click the **Next** button.
5. A **License Agreement** window will open.
Accept the agreement and click the **Next** button.
6. A **Customer Information** window will open.
Enter the appropriate information and click the **Next** button.
7. A **Destination Folder** window will open.
In the **Destination** window:
 - a. If you want the software to be installed in the default location, click the **Next** button.
 - b. If you want the software to be installed in a different location, click the **Change** button, navigate to the location where you want the software installed, and click the **OK** button.

8. A **Custom Setup** window will open.
 - a. Deselect the components that you do not want to install:

To deselect an item, click the  button beside the item and select the red X from the drop down menu that appears.

The example shown below assumes that you will only use Camera Link cameras, that your applications and software development only use C++, and that your PC uses an 32 bit operating system.

- b. Click the **Next** button.

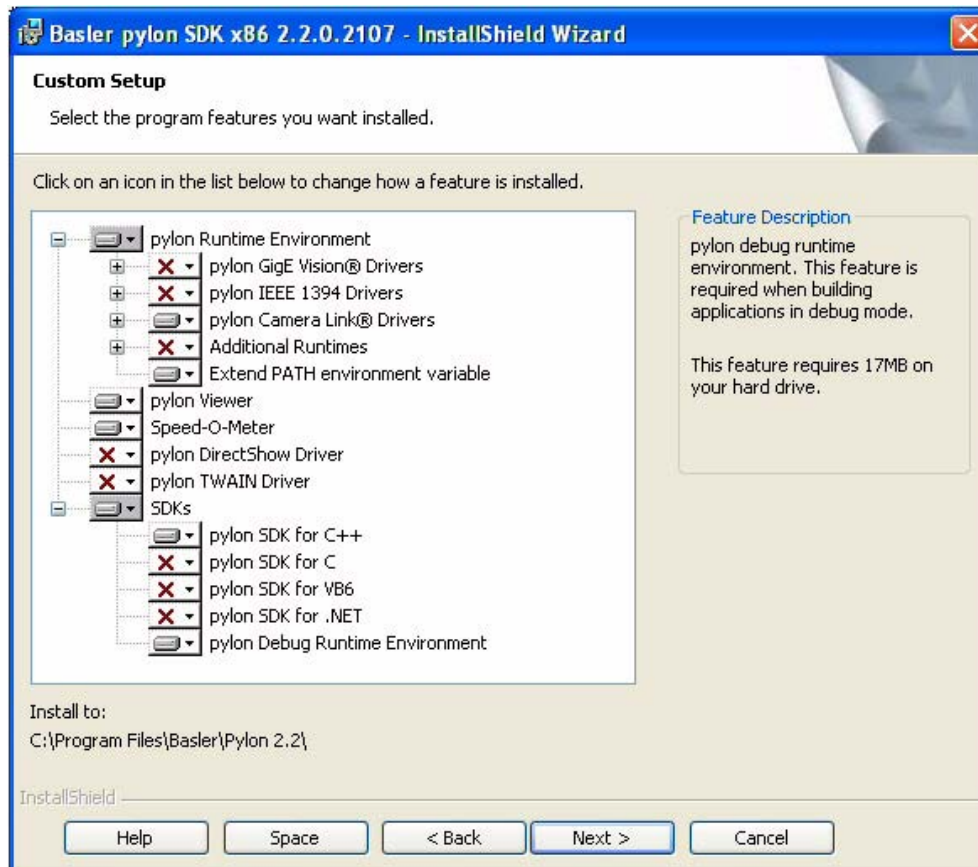

The deselected software features will not be installed. They will, however, be saved on your PC. Therefore, if you want to install them later, you can easily install them from your PC.

For more information, see the "Installing a Software Feature" section..

9. A **Ready to Install the Program** window will open.

Click the **Install** button.
10. When the installation process is complete, a **Completed** window will open.

Click the **Finish** button.

11. An **Installer Information** window may open informing you about the need to restart the computer.

- If you want to restart the computer now, click the **Yes** button.
- If you want to restart the computer later, click the **No** button.

If the **Installer Information** window does not open, there is no need to restart the computer.

Note that the installation program has added a shortcut to the desktop for the **Pylon Viewer**.

12. To see all of the installed software components:

Click **Start > All Programs > Basler Vision Technologies > Pylon 2.2**.

7.5 Configuring the Camera Link Serial Port

To communicate with the aviator camera, the pylon software uses a serial port that is built into the Camera Link interface on your frame grabber. Before pylon can communicate with the camera, you must configure the serial port.

To configure the Camera Link serial port:

1. Click **Start > All Programs > Basler Vision Technologies > Pylon 2.2 > Pylon CL Configuration Tool**.

2. A CIconfigurator window will open as shown below.

A list of ports that are supported by the Camera Link interface will be displayed in the window.

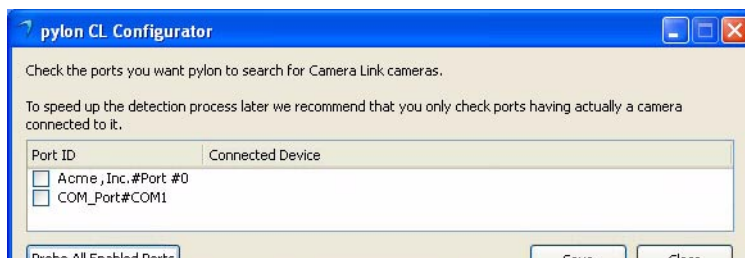

3. Determine which port will be used for communication between the PC and the aviator camera. Usually, this will be the port that is built into the frame grabber. For the port on the frame grabber, you will typically see the name of the frame grabber manufacturer included as part of the port name. In the example shown below, we are using a frame grabber from the "Acme" company, and "Acme" is included as part of the port name.

Check the port that you want to use as shown below.



In the following step, you will be probing ports to see if aviator cameras are attached. We suggest that you only probe the port(s) that you will be using to communicate with an aviator camera. Probing a port that has a device other than an aviator camera connected to it may change the configuration of the port and may cause the device to stop operating correctly.

4. In this step, you will probe the checked port(s) to see if an aviator camera is connected to the port. When the port is probed, the port configuration will be changed as required and then the configurator will attempt to establish communication with any camera connected to the port.

To probe the checked port(s), click the **Probe All Enabled Ports** button.

(You can also probe an individual port by right clicking on a port ID in the list and clicking on **Probe this port** from the menu that appears.)

5. The checked port(s) will be probed and if an aviator camera is detected, it will be indicated in the tool as shown below.

Click the **Save** button to save the port configuration and then click the **Close** button to close the tool.



7.6 Modifying Your Software Installation

You can install a software feature that you initially had deselected during the installation or remove a software feature that you initially installed, any time you want.



Note

The software feature to be installed must have the same version number as the Basler pylon software currently installed on your PC.

If in doubt, obtain the latest version of Basler pylon software and install it.

1. Make sure your camera is disconnected from your computer.
2. Use the Windows Add or Remove Programs function to add or remove a software feature:
 - Windows XP: **Start > Control Panel > Add or Remove Programs**
 - Windows Vista: **Start > Control Panel > Programs > Programs and Features**

8 Acquiring Images

8.1 Acquiring Your First Images

To adjust your camera's settings and to acquire and view your first images, we suggest that you use the pylon Viewer software. The following steps assume that you are using the pylon Viewer.

At this point, many of the camera's settings will be preliminary. Information about how to improve your image quality and to make camera settings more suitable for your specific application appear later in this section of this guide.

If you are using a GigE Vision camera, see also the camera User's Manual and the "Installing a GigE Vision Camera" section of this manual for improving your camera's performance in a network and on using multiple cameras.

Before attempting to acquire images, make sure that the camera software and hardware have been installed as described in the "Installing a GigE Vision Camera", "Installing an IEEE 1394 Camera", and "Installing a Camera Link Camera" sections, respectively.



For Camera Link cameras, the pylon Viewer can only be used for camera configuration. Images will not be displayed.

To change the camera's settings and acquire images:

1. Put an object within the camera's field of view.
2. Make sure that the object is properly illuminated. Use continuous illumination for this initial setup. If you want to use strobe light in your application, it is better to try this after the initial setup. If you need assistance in determining the optimum illumination for your application, contact Basler technical support using the numbers that appear in the title pages of this manual.

3. To start the pylon Viewer, doubleclick the  icon on your computer's desktop. The viewer window will open as shown below (the entry for a GigE Vision Basler scout camera is shown as an example).

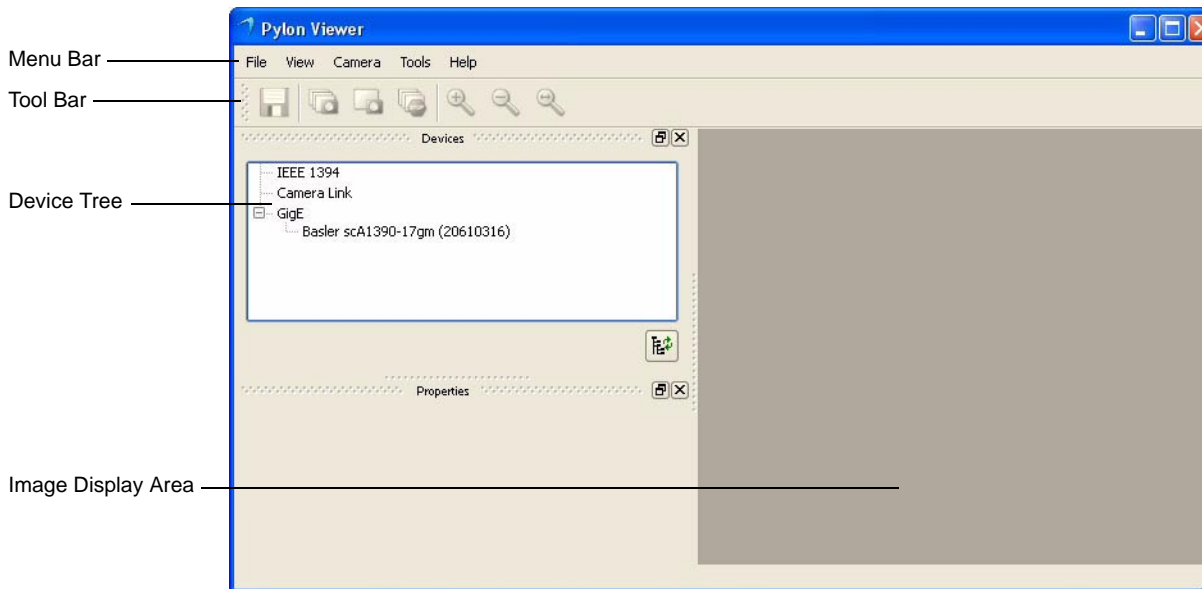

The device tree displays all available devices grouped by their type of interface (i.e., GigE, FireWire). All devices attached to a bus, including your camera, are also shown in the tree.

4. Click on your camera's name in the device tree to select the camera. A camera properties pane will open in the viewer as shown below.

You can use the selections in the camera properties pane to adjust all of the camera's settings such as gain, black level, and exposure.

Notice the user level selector drop down box that now appears in the lower left corner of the properties pane. You can select the beginner, expert, or guru user level. For the beginner level, the properties pane will display only the most basic camera settings. For the expert level, the properties pane will display all of the most commonly used camera settings. And for the guru level, the properties pane will display all camera settings including the most advanced settings.

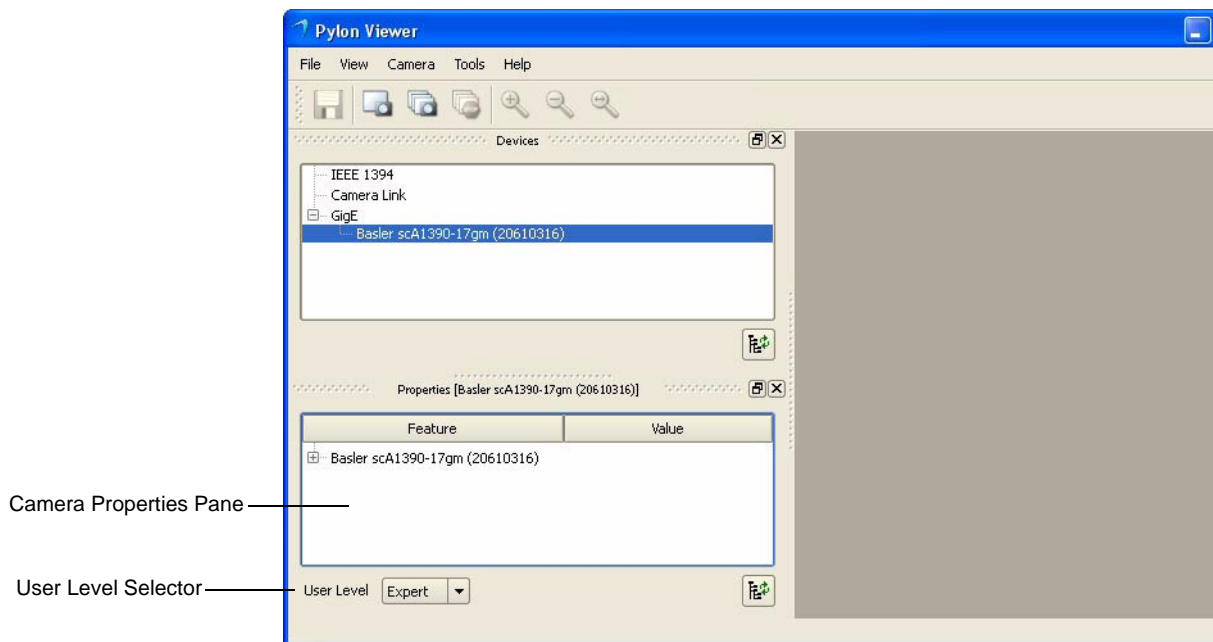

5. To get an initial feel for how to adjust your image quality, you will make adjustments to the camera lens and you will use the pylon Viewer to make adjustments to the camera's black level, gain, and exposure time settings. You will also use the viewer to capture images and to see what they look like.
6. Open the lens aperture "halfway" by choosing an intermediate f-number.
7. In the **Camera Properties Pane**, click the + **Sign** beside the **Transport Layer** category.
 - a. Set the **Packet Size** parameter to the maximum value.

8. Change the **Black Level** setting to a value between 16 and 32 and change the **Gain** setting to its lowest allowed value:
 - a. In the **Camera Properties Pane**, click the + **Sign** beside your camera's name. A list of setting categories will appear.
 - b. Click the + **Sign** beside the **Analog Controls** category. The controls for setting **Gain** and **Black Level** will appear as shown below.

You can set the **Black Level** by using the slider that appears next to the value box, by using the up / down arrows that appear next to the value box, or by typing a new value into the box.

You can set the **Gain** by using the slider that appears next to the value box, by using the up / down arrows that appear next to the value box, or by typing a new value into the box.

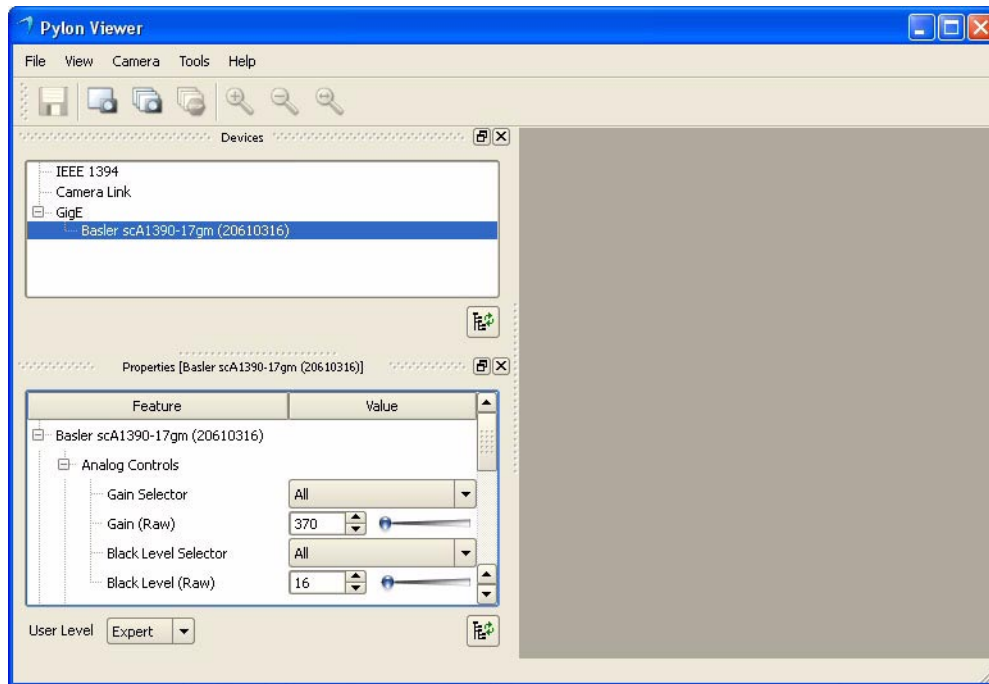

9. Change the **Shutter** setting to its lowest allowed value:
 - a. Click the + **Sign** beside the **Acquisition Controls** category. The controls for setting the **Exposure Time** will appear as shown below.
 - b. Use the slider to set the Exposure Time to its lowest allowed value.

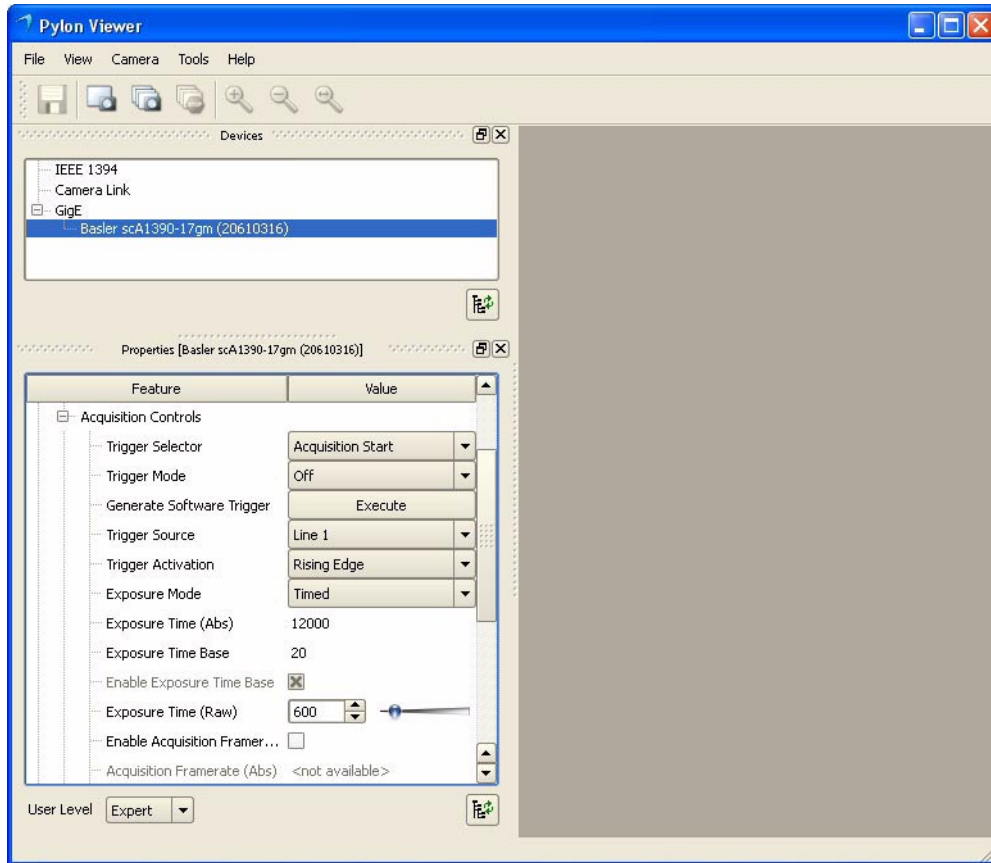

10. Click the  icon in the tool bar or press the F7 button or click **Camera** in the menu bar and select **Continuous Shot** from the drop down menu.

The camera will begin to acquire images continuously. The acquired images are displayed in an image display window as shown below.

With the current camera settings, the images you are seeing may be very dark or perhaps even black. The following steps assume that the current images are too dark.

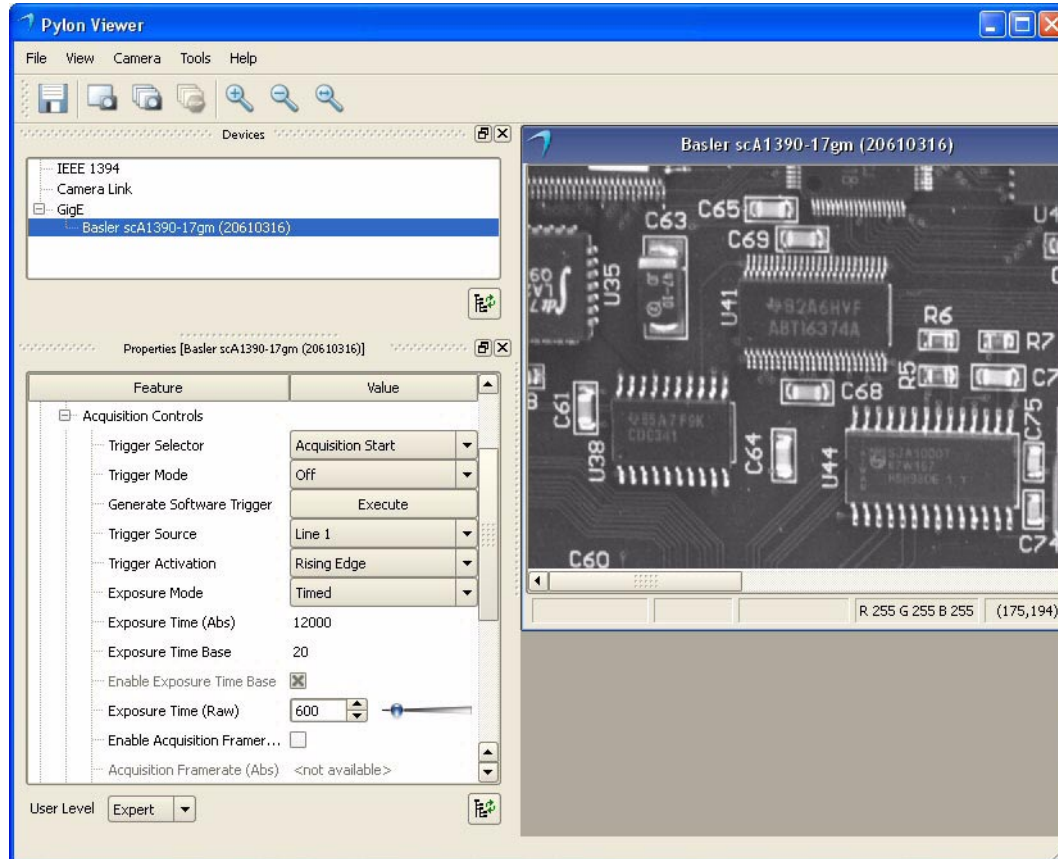

11. Increase the **Exposure Time** setting enough so that your image brightness is almost at the desired level. (The viewer is capturing and displaying images continuously, so you should see the effect of any setting change almost immediately.)
12. If required, increase the **Gain** setting slightly to improve the contrast.



Note: Make sure that detail is still visible in the brightest parts of the image. Increasing the Gain too much can cause the brightest parts of the image to lose detail. Increasing the Gain too much can also increase the noise in the acquired images.

If no image is visible, if it is not stable, or if the image displays artefacts, try one or both of the following:

- Go to the **Acquisition Controls** category and decrease the frame rate.
- Go to the **Transport Layer** category and decrease the packet size. (If you are using a GigE Vision camera, the network adapter to which your camera is connected, may not be able to handle the packet size used by the camera).

If you could solve the problem, return to step [11](#).

If you can not solve the problem, contact Basler technical support.

13. Adjust the focus ring on the lens so that the image is properly focused.
14. Adjust the lens aperture to fine tune the overall image brightness. Also take note of the depth of focus in the acquired images. Adjusting the aperture affects the depth of focus. (The next section contains more information about depth of focus.)
15. Make fine adjustments to the **Black Level** to ensure that detail is still visible in the darkest parts of the acquired images. (The next section contains more information about brightness.)
16. Adjust **Exposure Time**, **Gain**, and **Black Level** (in that order) to further improve the quality of the acquired images.
17. Stop image acquisition by clicking the  icon, by pressing the F8 button or by clicking **Camera** in the menu bar and selecting **Stop Grab** from the drop down menu.
18. Save the image in the display window by clicking the  icon or by clicking **Camera** in the menu bar and selecting **Stop Grab** from the drop down menu

Now that you have made the basic adjustments to your image quality, go on to the next section of the Installation procedure. The next section provides more detailed information about making adjustments to achieve the best image quality.

8.2 Adjusting Image Quality

In the following descriptions, we will discuss image quality in terms of focus, depth of focus, brightness and contrast. You can adjust image quality with regard to these criteria by choosing appropriate settings. However, the "best" image quality will partly depend on the specific requirements of your application and therefore no generally applicable "best" setting can be recommended.

The adjustments will involve the following:

- adjusting the brightness of the illumination
- adjusting the focus
- setting the lens aperture
- setting the black level
- setting the shutter
- setting the gain
- adjusting white balance.

In addition, the quality of an image will be affected by other factors, e.g., by the choice of the lens.

We recommend carrying out all fine adjustments using the illumination that you want to use in your actual application.

Focus:

You will obtain a focused image only if the lens is screwed into the lens adapter of the camera as far as it will go and if the glass surfaces are clean. The object to be imaged must be within the range of focus of the lens.

- You can obtain a focused image by turning the focal ring on the lens.

Depth of Focus:

If the objects you want to image are located at different distances from the camera, you must consider depth of focus. The depth of focus must be sufficiently deep to allow all objects to appear focused in the image.

- You can change the depth of focus by turning the aperture ring on the lens. Closing the lens aperture (turning the aperture ring to higher f-numbers) increases the depth of focus and vice versa.

Note that closing the aperture decreases the amount of light reaching the camera's sensor and therefore results in a darker image.

Brightness:

Among the factors determining the brightness of an image are the intensity of the illumination, the setting of the lens aperture, and the settings for black level, exposure time, and gain.

- We recommend that you choose bright illumination if possible, but avoid excessive intensity. This will prevent you from needing to operate the camera using extreme camera settings. A bright but not excessively bright illumination is of central importance to achieving good image quality.
- In images acquired from CCD sensors, excessive brightness will cause artifacts such as smear (white stripes in the image) and blooming (local over-saturation that destroys contrast). You can decrease the proneness for smear and blooming by choosing a diffuse and less intense illumination.
- If illumination of sufficient brightness is not available, you can select a lens that is optimized for light utilization.
- Opening the lens aperture will allow more light to reach the camera's sensor and will therefore increase the brightness of the image.

Note that opening the lens aperture also increases the effects of optical aberrations. This causes image distortions and the intensity of light decreases towards the edges of the sensor (vignetting). In addition, the depth of focus decreases.

- You can change the brightness of the image by changing the camera's black level setting. Normally, you should increase the black level setting only as far as is necessary to make detail visible in the darkest portions of an image. (This is equivalent to avoiding the clipping of the low gray values of noise.)

Note that high brightness settings will prevent high contrast. We recommend not using brightness settings above 64 when the camera is set for any output format that is greater than 8 bits per pixel.

- You can increase the brightness of the image by increasing the camera's exposure time setting. With this method, brightness is increased by increasing the amount of photons collected for pixel readout.

Note that increasing the exposure time setting may decrease the acquisition frame rate. If you are acquiring images of moving objects, increasing the exposure time setting may increase motion blur.

- Increasing the gain will also increase image brightness.

Note that unless your application requires extreme contrast, you should make sure that detail remains visible in the brightest portions of the image when increasing gain. Note also that noise is increased by increasing gain.

Exposure Time:

The exposure time setting determines the time interval during which the sensor is exposed to light.

- Choose an exposure time setting that takes account of whether you want to acquire images of still or moving objects:
 - If the object is not moving, you can choose a high exposure time setting (i.e., a long exposure interval).
Note that high exposure time settings may reduce the camera's maximum allowed acquisition frame rate and may cause artifacts to appear in the image.
 - If the object is moving, choose a low exposure time setting to prevent motion blur. As a general rule, choose a short enough exposure time to make sure that the image of the object does not move by more than one pixel during exposure.

Gain:

Gain amplifies each pixel readout by a certain factor. Accordingly, signal and noise are both amplified.

Note that it is not possible to improve the signal-to-noise ratio by increasing gain.

- You can increase the contrast in the image by increasing the camera's gain setting.
- Increasing gain will increase the image brightness.
Unless your application requires extreme contrast, make sure that detail remains visible in the brightest portions of the image when increasing gain. Note also that noise is increased by increasing gain.
- Set the gain only as high as is necessary.

Contrast:

Strong contrast in an image is obtained when objects of different brightnesses are represented by strongly different grey values. For most applications, optimum contrast is achieved when the image displays a wide range of gray values with fine detail remaining visible even in the darkest and brightest parts of an image. Some applications, however, may require extreme contrast.

- You can increase the contrast in the image by increasing the camera's gain setting. Gain amplifies the pixel readout.
- High black level settings will prevent high contrast. We recommend not using black level settings above 64 (at greater than 8 bit output).
- In images acquired from CCD sensors, contrast can be destroyed by local over-saturation (blooming) if the image brightness is too high. You can decrease the proneness for smear and blooming by choosing a diffuse and less intense illumination.
- Closing the lens aperture not only decreases image brightness but also increases contrast towards the edges of an image.
- If you must use insufficient illumination resulting in dark images, you may notice the blurring influence of noise. If you operate the camera near the high end of its specified temperature range, the effects may be particularly noticeable. You can increase contrast by lowering the operating temperature of the camera.

Note that it is not possible to improve the signal-to-noise ratio by increasing gain. Increasing the gain will increase both signal and noise in equal proportions.

White Balance:

- If you are using a color camera, the object that you use when adjusting the white balance should be a uniform gray and should fill the camera's entire field of view. Your white balance will be correct when images of this object show a uniform gray.
- Changing the black level setting will change the white balance. We therefore recommend that you check the white balance after setting the black level.
- Make sure the image is neither underexposed nor overexposed when checking the white balance.

9 Next Steps

We assume that you have succeeded in acquiring images and controlling the camera using the pylon Viewer and that you were able to optimize the image quality.

To meet the requirements of your application, you will likely need to make additional camera settings and to modify previous camera settings.

See the sections in your camera User's Manual describing camera operation and features for details about additional camera settings. See the Basler pylon Programmer's Guide and API Reference for information about setting and controlling the camera via a GenICam based API. We recommend controlling the camera via the API when taking the next steps.

Contact Basler technical support if you need further assistance. The contact numbers appear on the title page of this manual.

If you have not already done so, implement the typical conditions of operation as required by your application before proceeding with the next steps. In particular, choose the lens and the illumination required by your application.

Before making the additional camera settings, you must know the requirements for your application regarding depth of focus, acquisition frame rate, size of the AOI, and contrast. And you must know what the priorities of the requirements are since some of the settings depend on each other or have opposite effects. For example, a desired high acquisition frame rate may not be reachable with the exposure time set to a high value or with the area of interest set to full resolution.

Your next steps will involve all or some of the following:

- Selecting the pixel format and frame rate (scout and pilot cameras) or line rate (runner cameras).
- Defining an AOI.
- Controlling exposure by selecting a trigger scheme and by setting the exposure time. If you use an external device to supply the trigger, you must also connect the camera to the external device using the I/O cable.
- Controlling the frame rate (scout and pilot cameras) or line rate (runner cameras) by using the Acquisition Frame Rate Abs (scout and pilot cameras) or Acquisition Line Rate Abs (runner cameras) parameter or with trigger signals. If you are using more than one camera on the same network, choose the settings to make optimum use of the available network bandwidth.
- Enabling and parameterizing I/O signals.
- Enabling and parameterizing camera features.
- Save parameter settings as a user set.

Feedback

Your feedback will help us improve our documentation. Please click the link below to access an online feedback form. Your input is greatly appreciated.

<http://www.baslerweb.com/umfrage/survey.html>

Index

Symbols

.NET 2.0 framework redistributable
package.....13, 14

A

API.....14
API reference14
APIPA
 see automatic private IP addressing ..55
automatic private IP addressing55
Autonegotiation29

B

brightness, initial setup93

C

cables, conversion.....66
cables, IEEE 1394.....65
camera files for the frame grabber78
Camera Link configuration tool.....13
Camera Link driver13
cleaning the camera and sensor8
compatible chipset.....23, 41
compatible network adapter41
contrast.....94
CPU interrupts.....29

D

debug runtime environment.....14
depth of focus.....92
DHCP IP addressing55
DHCP server55
DirectShow driver14
driver
 Camera Link driver13
 Direct Show driver14
 GigE Vision network13
 IEEE 139413
 IEEE 1394 bus driver13
 IEEE 1394 camera driver13

performance driver13
TWAIN driver.....14

E

electromagnetic interference9
electrostatic discharge.....9
EMI9
ESD9
exposure time
 initial setup94
extend PATH environment variable.....13

F

filter driver.....13
fixed IP address.....48, 55
focus.....92
frame grabber camera files78

G

gain
 initial setup94

I

IEEE 1394 bus driver13
IEEE 1394 camera driver13
image quality, adjusting.....92
installation
 hardware38, 71, 78
 preparation21, 65, 75
interrupt moderation rate29
IP address55
IP address fixed.....48
IP configuration tool.....13

J

jumbo frames.....29, 44
jumbo packets44

L

laptop computer	65
lens, suggested choice	21, 75
lens, suggested choice	65

N

network adapter	
compatible.....	41
non-compatible	41
network adapter, recommended	21, 41
network architectures, recommended	42
network switch	43, 44
non-compatible network adapter.....	41

O

operating system.....	12
-----------------------	----

P

peer-to-peer networking	42
performance driver	13
persistent IP address	55
polarity, power.....	66
power requirements	35, 36, 65
programmer's guide	14
pylon	
API	14
Camera Link configuration tool	13
Camera Link driver.....	13
debug runtime environment	14
Direct Show driver.....	14
Driver Package	13
extend PATH environment variable ...	13
filter driver	13
IEEE 1394 bus driver	13
IEEE 1394 camera driver.....	13
IP configuration tool	13
performance driver.....	13
SDK.....	14
SDK for .NET	14
SDK for C.....	14
SDK for C++.....	14
SDK for VB6.....	14
TWAIN driver	14
Viewer	13, 85
pylon API.....	14

R

receive descriptors	29
runtime	13

S

sample programs	14
SDK	
.NET.....	14
C	14
C++	14
VB6	14
serial number	7
software development kit	
see SDK	
software features	13
speed and duplex mode.....	29
speed-o-meter tool.....	14
switches, network.....	43, 44
system requirements.....	12

T

TWAIN driver	14
--------------------	----

V

viewer.....	13
-------------	----

W

white balance	95
---------------------	----

Revision History

Document Number	Date	Changes
AW00061101000	14 Feb 2008	<p>Initial version:</p> <p>Transferred the following chapters from the User's Manuals of the scout-g (AW00011907000), scout-f (pylon) (AW00012505000), and pilot (AW00015109000) cameras: "Software and Hardware Installation", "Network Recommendations", and "Camera and Network Adapter IP Configuration".</p> <p>Restated precautions for the scout, pilot, and runner cameras.</p> <p>The instructions for SP2 partial rollback were not included from the Scout-f (pylon) User's Manual (they are now in the "Windows® XP SP2 Partial Rollback" Application Notes, AW000615xx000).</p> <p>Made adjustments for Basler pilot 2.0 software.</p> <p>Added instructions for setting and adjusting packet size and frame rate in Section 8.1.</p>

Document Number	Date	Changes
AW00061102000	20 Mar 2009	<p>General</p> <ul style="list-style-type: none"> ■ Made adjustments for Basler pilot 2.1 software. ■ Updated Basler webaddress. ■ Deleted sections concerning Basler pylon Driver Runtime Package. <p>Chapter 2</p> <ul style="list-style-type: none"> ■ Added a note on page 8 indicating that an application note regarding EMI/ESD control is available. <p>Chapter 3</p> <ul style="list-style-type: none"> ■ Adapted system requirements and installation packages. ■ Updated pylon software components section. <p>Chapter 5</p> <ul style="list-style-type: none"> ■ Adapted "Basler pylon Software Installation" on page 24. ■ Adapted "Adjusting the Installation" on page 27. ■ Adapted "Configuring a Network Adapter Used with the Filter Driver" on page 27. ■ Integrated "Disabling the Windows Firewall" on page 31. ■ Moved "limitation" note box to the beginning of section "Setting an Adapter to Use DHCP/Alternate Configuration = APIPA" on page 51. ■ Removed sections "Changing the Driver Association for a Compatible GigE Network Adapter", "Unbinding the Basler Filter Driver from a Network Adapter" and "Modifying Your Software Installation" to newly created section "Modifying the Installation" on page 61 at the end of the chapter. <p>Chapter 6</p> <ul style="list-style-type: none"> ■ Adapted "Installing the Basler pylon Software" on page 68. ■ Adapted "Modifying Your Software Installation" on page 73.
AW00061103000	8 Mar 2010	<p>General</p> <ul style="list-style-type: none"> ■ Updated the addresses in Germany and the U.S.A. ■ Made adjustments for Basler pilot 2.2 software. ■ Made additions/adjustments for Basler aviator and ace cameras. ■ Minor corrections and additions throughout the manual. <p>Chapter 4</p> <ul style="list-style-type: none"> ■ Removed instructions for removing the Basler filter driver of pylon versions 0.9 or below. <p>Chapter 7</p> <ul style="list-style-type: none"> ■ Added the "Installing a Camera Link Camera" section.